

# 2017 Ready-To-Run

*O Gauge Train Sets & Accessories*



**MTHE**  
ELECTRIC TRAINS®

*Build a World of Your Own in Three Dimensions™*

# A World of Your Own in Three Dimensions™



In a world where much childhood play takes place on a two-dimensional screen, model railroading offers a form of play that is both old-fashioned and timeless. For more than a hundred years, children have been using toy trains — along with construction sets, toy figures, empty boxes, and anything else at hand — to build their own imaginary worlds.

While all of this can be accomplished today on a computer screen, there's still enormous value in building something with your hands, making it operate, and sharing it with your friends. Childhood development experts call it “unstructured, imaginative, free play” and they say it helps kids grow mentally and socially. We just think it's fun, and having fun has to be a good thing.



## It's all here

In this catalog, we offer everything you need to build a miniature world of your own — or just put up a train around the Christmas tree, or anything in between. You'll find trains that are realistic and others that are whimsical, like our Halloween and Christmas sets.

Each of our ready-to-run O Gauge sets includes everything you need to get started, all in one box. Just download our app and you're ready to run trains with your Apple or Android smartphone or tablet.

To expand your layout, we offer well over a hundred RailTown™ buildings and accessories, O Gauge track systems, and a variety of safe, UL-approved transformers.



## Start With the Best

Like the toy trains of decades ago, our trains are designed to stand up to childhood play and provide years of enjoyment. Compare our sets with those of our competitors, and you'll find M.T.H. trains are made of better materials, run more smoothly, last longer, and have a better remote control system with more features, using long-range WiFi instead of Bluetooth. And every M.T.H. train set locomotive has the same Proto-Sound 3.0 sound and control system as our most expensive Premier line engines.



[www.mthtrains.com](http://www.mthtrains.com)

## See it in Action!



When you see this  icon, search for the item number on [www.mthtrains.com](http://www.mthtrains.com) to see a video of the item in action — or scan this QR code to see all of the product videos for this catalog!

[www.mthtrains.com/et-2017-rtr-catalog](http://www.mthtrains.com/et-2017-rtr-catalog)

# Contents

<b>M.T.H. Trains Are More Fun .....</b>	<b>2</b>
Why an M.T.H. set is the best way to start your model railroading journey	
<b>Ready-To-Run Train Sets .....</b>	<b>6</b>
All-in-one-box train sets, each with everything you need to get started	
<b>Holiday Offerings .....</b>	<b>14</b>
<b>Specialty Sets .....</b>	<b>24</b>
<b>Motive Power.....</b>	<b>27</b>
<b>Additional Cars.....</b>	<b>33</b>
<b>Accessories .....</b>	<b>36</b>
Buildings, signals, people and more, to help create your imaginary world	
<b>Track and Layouts.....</b>	<b>64</b>
Expand your empire with our track systems and layout packages	
<b>Transformers .....</b>	<b>84</b>
As your layout grows, choose from a variety of transformers to satisfy increasing power needs — all UL-approved for safety	
<b>Digital Command System .....</b>	<b>86</b>
When you're ready for the ultimate in 21st-century train control, check out DCS — the M.T.H. Digital Command System	
<b>M.T.H. Railroaders Club™ .....</b>	<b>90</b>
<b>www.mthtrains.com .....</b>	<b>92</b>

## What is O Gauge?

Model trains come in different sizes. The O Gauge trains in this catalog are nearly twice as large as HO Gauge, another popular train set size.

Compared with HO Gauge, O Gauge models are easier to handle, more rugged, stay on the track better, sound better due to a larger speaker size, and blend better with childhood construction toys.

One-Gauge trains, in comparison, are significantly larger and designed primarily for outdoor garden railroading.



Find your nearest M.T.H. Authorized Retailer at [mthtrains.com/dealer-search](http://mthtrains.com/dealer-search)

# M.T.H. TRAINS ARE **MORE FUN!**



M.T.H. trains are more fun because they feature the sights and sounds that make real trains dramatic and exciting — features that you can control from your smartphone or tablet as you walk around your layout:

### **Great Smoke**

Our steam engines feature fan-driven, puffing ProtoSmoke™, the most powerful smoke system in the hobby, and our Imperial diesel engines include ProtoSmoke diesel exhaust.

### **Speed Control**

Many toy trains have two speeds: fast and faster. M.T.H. locomotives feature the Proto-Sound® 3.0 sound and control system, which allows our engines to throttle down as slow as 3 scale miles per hour, highball down the main line, or maintain any speed in between. The Proto-Speed Control™ built into Proto-Sound locomotives acts like the cruise control on a car, keeping your train moving at the speed you select, regardless of hills and curves.

### Vivid Engine Sounds

Proto-Sound features crystal-clear digital sounds: the wail of a diesel horn; the melody of an authentic steam whistle; the bell alerting passengers to your arrival or departure; steam chuff or diesel roar; and crew conversations.

### Station Sounds

Proto-Sound passenger engines feature arrival and departure announcements of famous passenger trains. Freight engines include Freight Yard Proto-Effects™, a symphony of freight terminal sounds.

### Synchronized Chuff and Puff

Like a real steam engine, M.T.H. steamers feature puffs of smoke and steam chuff sounds synchronized with the drive wheels. Better than any other toy train, an M.T.H. locomotive portrays the drama of a steam engine slowly chuffing and puffing as it pulls out of a station and gets up to speed.

### Remote Uncoupling

Proto-Sound steam and diesel engines offer remote uncoupling anywhere on your layout, accompanied by the clank of the coupler opening and the hiss of air hoses parting.

### Remote Control from Your Smartphone or Tablet

Our 2017 ready-to-run sets feature an all-new WiFi receiver that allows you to run trains with your Android Smartphone or Apple iPhone. Simply download the M.T.H. DCS App from the Apple App Store or Google Play, and you're ready to send commands to the DCS Explorer and run trains. The DCS Explorer is a WiFi track interface unit that can be operated in stand-alone mode or incorporated into your home WiFi, and will respond to commands from multiple smartphones or tablets, including the iPad.



If you don't have a smartphone or tablet, you can still run your RailKing® train set remotely with the separately sold DCS Remote Commander, DCS Commander, or our top-of-the-line DCS Digital Command System, shown on pages 86-89.

If you prefer a traditional hard-wired power controller, pick any separately sold M.T.H. transformer on pages 84-85.

Either way, you'll be controlling a train set that can grow and expand with your interest in model railroading — because it features the same industry-leading Proto-Sound 3.0 sound and control system as our most expensive Premier Line locomotives.

### DCS Digital Command System with WiFi Offers:

#### Locomotive Features

- Speed Control
- Horn/Whistle
- Bell
- Front Coupler Activation (if equipped)
- Rear Coupler Activation
- Smoke On/Off (if equipped)
- Headlight On/Off
- Locomotive Sound Volume
- Sound Mute
- Passenger Station/Freight Yard Sounds
- Doppler Effect Sounds (train approaching, passing and receding)
- Locomotive Factory Reset

#### Additional Features

- Up to 100' range
- Multiple-engine control
- Easily and quickly switch between locomotives
- Fast bi-directional communication
- Auto-programming (automatically recognizes new locomotives)
- In-App M.T.H. Shopping
- M.T.H. news, videos, online catalogs and website search
- M.T.H. newsletter signup
- Download user manuals

DCS Explorer  
Track Interface Unit  
50-1035 \$129.95  
*(WiFi receiver included with Ready-to-Run sets at no extra charge)*



**All Ready-to-Run Sets operate with your smartphone or tablet and the free M.T.H. DCS App**



# The Highest Quality Train Sets You Can Buy

At M.T.H., we consider the ready-to-run train set our best opportunity to make a great impression on newcomers to model railroading. That's why we don't skimp on the quality and value you'll find in every M.T.H. ready-to-run starter set. Compare our sets with those of our competitors and you'll see what makes an M.T.H. starter set the best way to begin your model railroading journey.

M.T.H. ready-to-run train sets include track, power supply, DCS Explorer WiFi receiver, interactive DVD with track layout software and an operator's manual.



Every M.T.H. passenger car has a lighted interior and metal trucks and couplers.

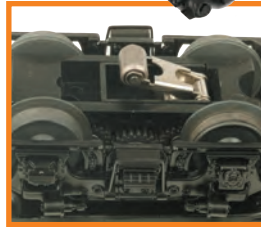

Every M.T.H. locomotive features durable metal gears, wheels and axles.



Every M.T.H. locomotive features a smooth, powerful drive train that can haul many additional cars.



Every M.T.H. Ready-to-Run Set features snap-together track built to withstand the rigors of childhood play. You can even stand up on our O gauge track.



M.T.H. train sets include robust power supplies and a digital command system you operate from **your** Android smartphone or tablet or Apple iPhone or iPad.



# READY-TO-RUN SET FEATURES

As explained on the previous pages and detailed below, M.T.H. train sets are loaded with features you won't find in other manufacturers' sets. The following list covers the general features and contents of our train sets. For a specific listing of each set's features and contents, visit our Web site at [www.mthtrains.com](http://www.mthtrains.com).

## SET CONTENTS

### 0 Gauge RailKing Sets include:

- Locomotive
- 3-Car passenger or freight consist with metal trucks and couplers
- 31" x 51" 12-piece RealTrax™ oval
- Lighted track Lock-on with wire harness
- UL-approved 50-watt, 5 amp power supply
- DCS Explorer Track Interface Unit with WiFi\*
- RailWare™ interactive DVD with track layout software

*\*Requires free M.T.H. DCS App and user-supplied Android smartphone or tablet or Apple iPhone or iPad.*

## LOCOMOTIVE FEATURES

### 0 Gauge RailKing Proto-Sound 3.0 Steam Engines Feature:

- Die-cast metal boiler and chassis
- Flywheel-equipped motor
- Synchronized puffing Proto-Smoke™
- LED headlight
- All-metal wheels and gears
- Proto-Sound 3.0 sound and control system with locomotive speed control and crystal-clear digital sounds that include whistle, bell, steam chuff, Passenger or Freight Station Proto Effects™, crew conversations, and atmospheric sounds
- Remotely controlled Proto-Coupler™ on tender

### 0 Gauge RailKing Proto-Sound 3.0 Diesel Engines Feature:

- Intricately detailed, durable ABS body
- Metal frame

- Die-cast metal pilots and trucks
- Twin flywheel-equipped motors
- LED headlight
- All-metal wheels and gears
- 2 remotely controlled Proto-Couplers
- Proto-Sound 3.0 sound and control system with locomotive speed control and crystal-clear digital sounds that include horn, bell, diesel motor, Passenger or Freight Station Proto-Effects™, crew conversations, and atmospheric sounds.

## ROLLING STOCK FEATURES

- Sprung metal, die-cast freight trucks with metal operating couplers
- Die-cast metal passenger trucks with metal operating couplers
- Intricately detailed, durable ABS bodies
- Passenger car interiors with operating overhead lighting
- Caboose operating interior lighting



Check online at [www.mthtrains.com](http://www.mthtrains.com) for specific features and contents of all sets.



# Pennsylvania Eagle

## Steam Freight Set



Includes Everything You Need  
To Run Your Set With  
Your Smartphone or Tablet.



Pennsylvania - *Eagle* Steam Freight Set with Proto-Sound 3.0  
30-4244-1 \$469.95



Pennsylvania - 4-Bay Hopper  
30-75573 \$54.95



Pennsylvania - Gondola with  
Removable Covers  
30-72188 \$54.95



Pennsylvania - Flat Car with  
Die-Cast '53 Ford Pickup Trucks  
30-76669 \$64.95

In its heyday, the Pennsylvania Railroad was one of the largest transportation systems the world had ever seen. Over its 30,000 miles of track roamed thousands of locomotives and tens of thousands of cars, most of them designed by the railroad itself and many of them built in the road's own shops in Altoona, PA. The Pennsy's conquest of the Appalachian Mountains at Horseshoe Curve, just west of Altoona, was and still is a landmark of railroad engineering, carrying freight and passengers between the East and the Midwest.

Relive the glory days of the "Standard Railroad of the World" with this rugged, hard-working freight set, named after the Pennsy's *Eagle* freight service that crossed the Appalachians to connect eastern cities with Ohio and points west. For its huge plumes of puffing smoke, deep chuffing sound, and wailing whistle, it's easy to imagine you're battling your way across Horseshoe Curve to deliver goods to the nation's heartland. For even more fun, add extra cars decorated for the Pennsylvania and other railroads — with its eight powerful drive wheels, this heavy, die-cast steam locomotive has plenty of power to pull them!



# Southern Pacific Overnight

## Steam Freight Set



Includes Everything You Need  
To Run Your Set With  
Your Smartphone or Tablet.



Southern Pacific - *Overnight* Steam Freight Set with Proto-Sound 3.0  
30-4245-1 \$469.95



Southern Pacific - 4-Bay Hopper  
30-75574 \$54.95



Southern Pacific - Gondola with  
Removable Covers  
30-72189 \$54.95



Southern Pacific - Flat Car with  
(2) Die-Cast VW Buses  
30-76677 \$64.95

The Southern Pacific and the state of California grew up together. Founded in 1865 by a group of San Francisco businessmen, the railroad eventually stretched over 13,000 miles, connecting the Golden State with Portland to the north and points east as far as New Orleans, Kansas City and Chicago. The Espee, as it was often called, was known for innovation and larger-than-life projects, from some of the earliest shipments of California fruit to the rest of the nation, to its *Daylight* passenger trains along the Pacific coastline and its crossings of some of our country's toughest mountain ranges.

Recreate the excitement of steam era railroading in the Southwest with this freight set named after Southern Pacific's famed *Overnight* service. Long before FedEx existed, it provided overnight business deliveries between San Francisco and Los Angeles, carrying everything from groceries to replacement car engines. Leading this set is a rugged 2-8-0 steam locomotive with puffing smoke and chuff sounds synchronized to the drive wheel revolutions; Proto-Speed Control for smooth and steady speeds from a crawl to full throttle; LED headlight to light up the night; and a full range of sounds from wailing whistle and clanging bell to squealing brakes and crew conversations.

# Amtrak Merchants Limited F40PH Diesel Passenger Set



Amtrak - F40PH Diesel Passenger Set with Proto-Sound 3.0  
30-4246-1 \$469.95

Upon its creation in 1971, Amtrak inherited a motley collection of beat-up cars from the nation's former passenger carriers. With a mission to attract passengers back to train travel, one of Amtrak's first orders of business was to create a modern passenger fleet. The first of nearly 650 new Amfleet cars was delivered in 1975, with a sleek, rounded body that looked more like an aircraft fuselage than a traditional passenger car. Amfleet cars gave passengers the feel of traveling in a modern jetliner — but with more room and better views.

At the same time, Amtrak introduced its F40PH passenger diesel, intended for commuter and medium-haul service as a complement to new long-haul locomotives. But when those larger engines proved trouble-prone, the 3000 hp F40PH stepped up as the little engine that could. It

took over passenger runs from coast to coast and became the backbone of Amtrak's locomotive fleet for decades.

This set replicates the F40PH-powered Amfleet trains that were the first step in Amtrak's revival of the U.S. passenger train. Its Proto-Sound 3.0-equipped diesel features Proto-Speed control for smooth, steady speeds from a crawl to full throttle; remote-controlled Proto-Couplers; and LED lighting. It also offers a full symphony of train sounds, from diesel motor to wailing horn, clanging bell, crew conversations and arrival and departure announcements for the *Merchants Limited* — which ran along the famous Shoreline route from Boston to New Haven, where the *Limited* switched to electric locomotives that would take it south to New York and Washington, DC.



Amtrak - 2-Car O-31 Amfleet Coach/Cafe Set  
30-6528 \$149.95



# Union Pacific Dash 8 Diesel Freight Set



Includes Everything You Need  
To Run Your Set With  
Your Smartphone or Tablet.



Union Pacific - Dash 8 Diesel Freight Set with Proto-Sound 3.0  
30-4241-1 \$449.95



Union Pacific - 4-Bay Hopper  
30-75576 \$54.95



Union Pacific - Gondola with  
Removable Covers  
30-72190 \$54.95



Union Pacific - Flat Car with  
Die-Cast '53 Ford Pickup Trucks  
30-76670 \$64.95

On May 10, 1869, the Union Pacific and Central Pacific railroads met at Promontory Point, Utah to complete the first transcontinental railroad. Wagon trains and clipper ships were no longer the only way to the West Coast. More than a century later, the Central Pacific is gone but the Union Pacific is the largest railroad in North America, with more than 8,000 locomotives, 100,000 freight cars, and 32,000 miles of track in 23 states. Due to shared motive power agreements with other railroads, its famous Armour Yellow diesels can be spotted anywhere from Los Angeles to Boston.

Capture the high-horsepower drama of modern railroading with this UP freight set, headed by our twin-motored replica of General Electric's Dash 8 diesel. A best-seller for GE from 1987-1994 and still in wide use today, the Dash 8 helped pioneer computer control of locomotive functions, from engine control to troubleshooting to making sure all 12 wheels were gripping the track and not slipping. Our model of this landmark locomotive features an LED headlight to light up the night; Proto-Speed Control for smooth, steady speeds from a crawl to full throttle; traction tires for tremendous pulling power; and a full range of sounds from blaring horn and clanging bell to squealing brakes and crew conversations.

# Norfolk Southern First Responders Dash 8 Set



Includes Everything You Need  
To Run Your Set With  
Your Smartphone or Tablet.



Norfolk Southern (First Responders) - Dash 8 Diesel Freight Set with Proto-Sound 3.0  
30-4239-1 \$449.95



Norfolk Southern (First Responders)  
Smoking Tank Car for Hazmat Training  
30-73521 \$79.95



Norfolk Southern (First Responders)  
Box Car w/Blinking LEDs  
30-74885 \$79.95

Norfolk Southern (First Responders)  
60' Streamlined Baggage Car  
30-67993 \$74.95



Unveiled at Washington, D.C.'s Union Station in June 2015, Norfolk Southern's engine No. 911 honors the dedication and sacrifices of our nation's first responders. It features the Maltese Cross of fire services, the Emergency Medical Services' "Star of Life," and the Police shield. In addition, engine 911 underscores the railroad's commitment to its Operation Awareness & Response (OAR) outreach program for hazmat training, which reaches thousands of emergency first responders each year in lineside communities across 18 states.

Our set and additional add-on cars are based on the Norfolk Southern's Hazmat Safety Train, which travels the NS system to provide classroom and hands-on training, tabletop simulations, and full-scale emergency response training exercises. The railroad has been recognized as a national leader in helping communities prepare for and respond to hazmat transportation incidents.



Norfolk Southern (First Responders) - 33K Gallon Tank Car  
30-73499 \$64.95



Norfolk Southern (First Responders)  
Modern Tank Car  
30-73500 \$64.95



Norfolk Southern (First Responders)  
Fire Car  
30-79541 \$59.95

Norfolk Southern (First Responders)  
50' Double Door Plugged Boxcar  
30-74874 Car No. 490411 \$59.95  
30-74875 Car No. 490911 \$59.95



Norfolk Southern (First Responders)  
Operating Action Car  
30-79526 \$79.95  
*Features Illuminated, Moving First  
Responder Vehicles*

# Norfolk Southern Veterans

## Dash 8 Set

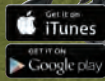

Includes Everything You Need  
To Run Your Set With  
Your Smartphone or Tablet.



Norfolk Southern (Veterans) - Dash-8 Diesel R-T-R Freight Set with Proto-Sound 3.0  
30-4240-1 \$449.95



Norfolk Southern (Veterans)  
Box Car w/Blinking LEDs  
30-74886 \$79.95



Norfolk Southern (Veterans)  
60' Streamlined Baggage Car  
30-67994 \$74.95

Norfolk Southern (Veterans) 50'  
Double Door Plugged Boxcar  
30-74884 \$59.95



The Norfolk Southern's Veterans Locomotive is a rolling reminder of the contributions and sacrifice of our nation's military personnel. Unveiled just before Veteran's Day in 2012 at the road's Altoona, PA shops, engine 6920's paint scheme was selected by a group of 18 NS employees representing all branches of the armed forces. Equally important is the railroad's commitment to hiring and training veterans; nearly 4,000 of the railroad's 28,000 employees are veterans and members of the National Guard and Reserves.



Norfolk Southern (Veterans) - 33K Gallon Tank Car  
30-73518 \$64.95



Norfolk Southern (Veterans)  
Modern Tank Car  
30-73517 \$64.95



Norfolk Southern (Veterans)  
Smoking Tank Car  
30-73522 \$79.95



Norfolk Southern (Veterans)  
Operating Action Car  
30-79527 \$79.95  
*Features Illuminated, Moving  
Service Logos and Flags*

# Canadian Pacific Holiday Train



**RAILKING**  
scale

**O**  
gauge



Canadian Pacific - 4-Car 50' Double Plugged Door Boxcar Set with LED Lights  
30-7087     \$319.95



Canadian Pacific - 60' Madison Observation Car *Van Horne*  
30-69233   \$74.95



Canadian Pacific - 60' Madison Observation Car *Killarney*  
30-69232   \$74.95



Christmas - 4-Car 50' Double Plugged Door Boxcar Set with LED Lights  
30-7088     \$319.95





Every year since 1999, the Canadian Pacific's Holiday Train has plied CP rails between Montreal and the Pacific coast, helping over a hundred towns and cities celebrate the season by supporting their local food bank. At each stop, a boxcar opens up to become the stage for a traveling band. Trailing passenger cars accommodate Santa and his helpers. Performances are free, but guests are asked to bring donations for the local community's food bank. In its first 18 seasons, the train has raised over \$143 million and 4 million pounds of food donations.

There are two sections of the Holiday Train, one traveling across southern Canada and the other visiting CP rails in the northern U.S. Our model represents the 2009 version, which ranged as far south as Scranton, PA. For modelers farther south, we also offer a non-CP version to create your own expression of the holiday spirit.

Heading both trains is our twin-motored scale model of General Electric's Dash 8 diesel, featuring Proto-Speed control for smooth, steady speeds from a crawl to full throttle; remote-controlled Proto-Couplers; LED-Illuminated headlight, number boards, cab interior and holiday lights; variable-intensity ProtoSmoke diesel exhaust; and a full symphony of train sounds, from holiday arrival music to diesel sounds, wailing horn, clanging bell and crew conversations.



Canadian Pacific - RailKing Scale Dash 8 Diesel  
with Proto-Sound 3.0  
30-20435-1 \$399.95



Canadian Pacific - 60' Madison Observation Car *Strathcona*  
30-69231 \$74.95



Christmas - RailKing Scale Dash 8 Diesel  
with Proto-Sound 3.0  
30-20436-1 \$399.95

# Christmas ES44AC Imperial Diesel & Caboose Set



Christmas - ES44AC Imperial Diesel & Caboose Set With Proto-Sound 3.0  
30-20430-1 \$399.95



Diesel Exhaust Smoke! Flashing Red & Green Battery Charging Lights Along Underbody!



Christmas - Smoking Tank Car  
30-73520 \$79.95



See  
Charging Lights  
in Action



Christmas - Box Car  
30-74890 \$59.95

# Christmas 4-4-0



Christmas - 4-4-0 1860's Steam Engine with Proto-Sound 3.0  
 30-1727-1 \$449.95  
 Includes Puffing Smoke, LED Headlight and Christmas Sounds



Christmas - 3-Car Overton Passenger Coach Set  
 30-6443 \$199.95



Christmas - Flat Car with Lighted Christmas Trees  
 30-76684 \$79.95

Christmas - Flat Car with Lighted Christmas Trees  
 30-76685 \$79.95



Christmas - Flat Car with Lighted Christmas Trees  
 30-76683 \$79.95

# Holiday Rolling Stock

Christmas - Snow Cannon  
30-79542 \$59.95



Christmas - Flat Car with  
40' Trailer  
30-76687 \$64.95



North Pole - Flat Car with Lighted  
Christmas Trees  
30-76682 \$79.95



North Pole - Flat Car with Lighted  
Christmas Trees  
30-76681 \$79.95



North Pole - Snow Maker  
30-79543 \$59.95





North Pole - Box Car with Blinking LEDs  
30-74888 \$79.95



North Pole - Operating Action Car  
30-79545 \$79.95  
*Features Illuminated, Moving Skaters*



Christmas (Traditional) - Box Car  
30-74889 \$59.95



Christmas (Traditional) - 2-8-0 Steam Engine with Proto-Sound 3.0  
33-1046-1 Cab No. 1225 \$299.95  
*Includes Puffing Smoke, LED Headlight and Christmas Sounds*

# Holiday Accessories



Arch Bridge (40-1115)  
shown with two optional  
Girder Bridges (40-1116)



Red - O Girder Bridge with  
Operating Christmas Lights  
40-1116 \$59.95  
Measures: 10" x 5 1/8" x 9"



Red - O Steel Arch Bridge w/  
Operating Christmas Lights  
40-1115 \$149.95  
Measures: 30" x 5 1/8" x 14"



#4 Country House w/Operating Christmas Lights -  
Dark Blue and Brown  
30-90546 \$79.95  
Measures: 9 5/8" x 5" x 7"



#4 Country House w/Operating Christmas Lights -  
Light Gray and Teal  
30-90545 \$79.95  
Measures: 9 5/8" x 5" x 7"



Washington - Country Passenger Station w/Operating Christmas Lights  
30-90549 \$89.95  
Measures: 18 5/8" x 7 3/8" x 6 5/8"

## Buildings Feature Interior Lighting



North Pole - Country Passenger Station w/Operating Christmas Lights  
30-90525 \$89.95  
Measures: 18 5/8" x 7 3/8" x 6 5/8"



Ye Olde Christmas Shop - Road Side Stand w/Operating Christmas Lights  
30-90563 \$69.95  
Measures: 8 1/2" x 5 7/16" x 4 1/4"

North Pole - Trackside Yard Tower  
30-90536 \$39.95  
Measures: 4" x 4" x 7 1/2"



North Pole - Power Station  
30-90535 \$34.95  
Measures: 4 1/4" x 4 1/8" x 3 7/8"



North Pole - 314 Die-Cast Girder Bridge  
30-12014 \$34.95  
Measures: 10" x 4 1/2" x 1 3/4"



#6 Farm House w/Operating Christmas Lights - Yellow Tan and Dark Green  
30-90547 \$79.95  
Measures: 7 1/2" x 7 1/2" x 7"



#6 Farm House w/Operating Christmas Lights - Brick Red and Gray  
30-90548 \$79.95  
Measures: 7 1/2" x 7 1/2" x 7"

# Halloween Train



Halloween - ES44AC Imperial Diesel & Caboose Set  
With Proto-Sound 3.0  
30-20429-1

\$399.95



See  
Charging Lights  
in Action



Halloween - Box Car with Glowing LEDs  
30-74887

\$79.95



Halloween - Flat Car with 40' Trailer  
30-76686

\$64.95





If you've been a fan of our traditionally themed Halloween cars over the past 10 years, then this locomotive and caboose set is the perfect way to build your very own Halloween train. With its spooky sounds and variable-intensity exhaust smoke, this Imperial series diesel and its bay-window caboose make great bookends to your Halloween car collection — no matter whether you've got every car in the series or are just starting out.

Our near-scale model of General Electric's ES44AC diesel is a full 17" in length, yet oper-

ates comfortably on O-31 curves. Under the hood is the very same Proto-Sound 3.0 sound and control package found in our more expensive Premier model of this locomotive, with sounds recorded from the actual prototype. Imperial features include operating diesel exhaust smoke, flashing ditch lights, colorful charging lights running the length of the body, and unique Halloween sound effects. If you're looking for a locomotive to complement your holiday décor, and powerful enough to pull all of our traditional Halloween cars, it doesn't get any better than this. Turn down the lights and run your own Halloween Special!



Happy Halloween - Box Car  
30-74891 \$59.95

Halloween - Smoking Tank Car  
30-73519 \$79.95

**Frighten your guests with simulated poisonous vapors!**



**Watch the illuminated ghosts fly by!**

Halloween - Operating Action Car  
30-79544 \$79.95

# Norfolk Southern ES44AC Imperial Diesel & Caboose Sets



Norfolk Southern (ECO) - ES44AC Imperial Diesel & Caboose Set

With Proto-Sound 3.0

30-20431-1

\$399.95

When an automobile is recycled, nothing much remains but molten metal. When a modern diesel locomotive is recycled, however, the frame and much of the exterior is re-used, while internal organs are replaced or upgraded. In an era when a new freight locomotive can cost upwards of \$2 million, recycling old power makes both economic and ecological sense.

These models showcase the locomotive recycling efforts of the Norfolk Southern railroad. ECO engine 4700, assigned to yard service in the Chicago area, is one of a group of engines rebuilt in 2015–2016 to deliver lower emissions in major urban areas. The program was partially funded by

Federal and state environmental grants — hence the map of Illinois and the slogan “Working Together for a Cleaner State” on its sides.

Locomotives 4000 and 4002 are lead engines in the “DC to AC” program begun in 2015, to upgrade 20-year-old diesels with more horsepower, lower emissions, more comfortable cabs, and conversion to AC electric motors in their 6-axle trucks. Compared with the DC motors that were once standard on diesels, AC motors can start a heavier train with the same engine horsepower; in effect, they put more of the locomotive’s horsepower on the rails.





Norfolk Southern - ES44AC Imperial Diesel & Caboose Set With Proto-Sound 3.0  
30-20432-1 Cab No. 4000 \$399.95



Norfolk Southern - ES44AC Imperial Diesel & Caboose Set With Proto-Sound 3.0  
30-20434-1 Cab No. 4002 \$399.95

# Freedom ES44AC Imperial Diesel & Caboose Set



Freedom - ES44AC Imperial Diesel & Caboose Set  
With Proto-Sound 3.0  
30-20433-1

\$399.95



See  
Charging Lights  
in Action



Freedom - Flat Car  
with 40' Trailer  
30-76689 \$64.95

Model the ground-shaking, high horsepower drama of modern railroading with this General Electric Evolution Series (EVO) ES44AC. At the heart of the Evolution Series is a 4400 hp diesel motor designed specifically to comply with new Environmental Protection Agency regulations. GE claims the EVOs are "the most fuel-efficient, most environmentally friendly diesel locomotives in history... If every freight train in North America were pulled by an Evolution Series Locomotive, the reduction of smog-producing pollutants would be like removing 48 million cars from the road each year."

Our near-scale Imperial Series model is based on the experimental Evolution Hybrid ES44AC, which features hybrid battery power and flashing charging lights along its underbody. Our model is a full 17" in length, yet operates comfortably on O-31 curves. Under the hood is the very same Proto-Sound 3.0 sound and control package found in our more expensive Premier model of this locomotive, with sounds recorded from the actual prototype. Additional Imperial features include variable-intensity diesel exhaust smoke, flashing ditch lights, flashing charging lights and remote-controlled couplers so you can pick up and drop off a train anywhere on your layout.



Diesel Exhaust Smoke!  
Flashing Red, White & Blue Battery Charging Lights Along Underbody!

# Bump-n-Go Trolley

This colorful trolley features a lighted interior, metal wheels and gears, and a long-lasting motor. It operates on any O Gauge track system including the easy-to-assemble RealTrax® system. Optional track bumpers can be added to take advantage of the Automatic Bump-Reverse Mechanism (ABRM) that changes the trolley's direction when it hits a track bumper.

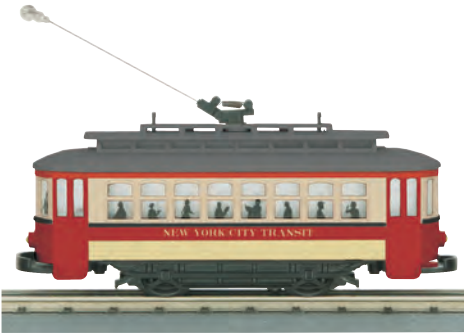

New York Transit - Bump-n-Go Trolley  
30-5139 \$79.95

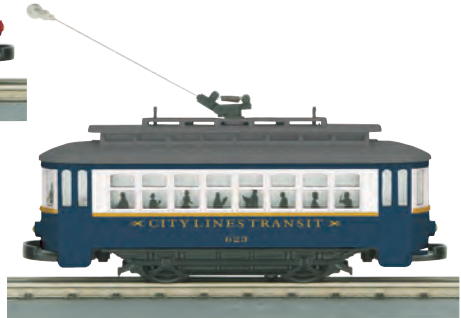

City Lines - Bump-n-Go Trolley  
30-5140 \$79.95

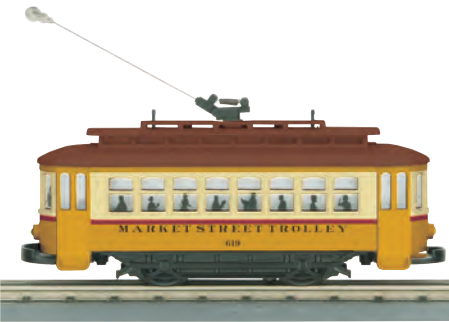

Market Street - Bump-n-Go Trolley  
30-5141 \$79.95

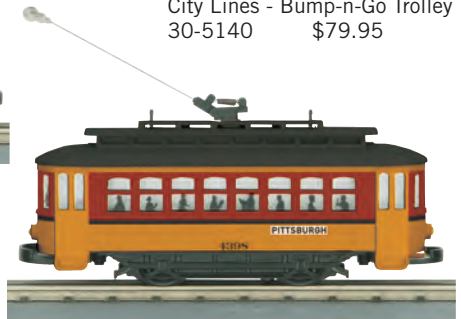

Pittsburgh - Bump-n-Go Trolley  
30-5142 \$79.95

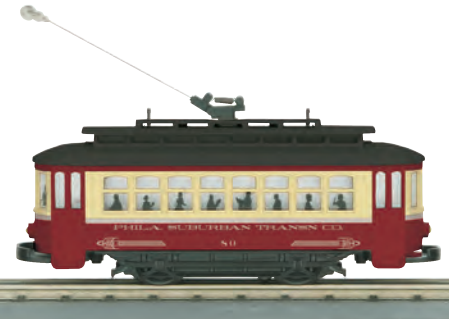

Philadelphia - Bump-n-Go Trolley  
30-5143 \$79.95



Christmas - Bump-n-Go Trolley  
30-5146 \$79.95



**Trolley automatically reverses when it hits a bumper.**

# RailKing® Steam Locomotives



On the following pages you'll find a variety of exciting steam-era locomotives.

**Our Forty-Niner series** is based on a Union Pacific engine streamlined in 1937 to haul the UP's leg of the *Forty Niner*, a Chicago to San Francisco streamlined, all-Pullman train jointly operated by the Chicago & North Western, Union Pacific, and Southern Pacific Railroads. With valet and stewardess services as well as a shower and a barber shop, the *Forty-Niner* offered a way to travel west in style. Oddly, the UP painted the engine for its portion of the run in its own streamliner colors of Leaf Brown and Armour Yellow, with red striping — a beautiful paint scheme, but not at all a match for the gunmetal grey trainset the engines were designed to pull.

**Our Crusader series**, like our Forty-Niner, is based on a streamlined train launched in the depths of the Great Depression, when railroads

saw streamlining as a way to attract the public back to train travel. The premier express of the Reading Railroad, the *Crusader* was named by a contest winner in 1937; in those lean Depression years, the prize of \$250 drew 6,086 entries. The five-car, stainless steel *Crusader* was a deluxe commuter train, making a daily 90-mile dash between Philadelphia's Reading Terminal and Jersey City's Communipaw Terminal, where passengers could take a ferry to lower Manhattan.

**Our B-6 switcher** models the rugged little steamers that switched railroad yards nationwide and delivered cars to factories and warehouses.

All of these Imperial engines feature puffing smoke, real tender coal loads, hand-painted crew figures and a host of other Imperial details. For more information on each model, search on its item number on [www.mthtrains.com](http://www.mthtrains.com)

## 2-8-0



Pennsylvania - 2-8-0 Steam Engine with Proto-Sound 3.0

33-1045-1 Cab No. 7555 \$299.95

Includes Puffing Smoke, LED Headlight and Freight Locomotive Sounds

# 4-6-2 Forty-Niner



Union Pacific - 4-6-2 Forty-Niner Steam Engine  
30-1704-1 Cab No. 2906 \$459.95

*Add matching passenger sets —  
see our 2017 volume 1 catalog at  
[www.mthtrains.com](http://www.mthtrains.com)*



Norfolk & Western - 4-6-2 Forty-Niner Steam Engine  
30-1707-1 Cab No. 540 \$459.95



Southern Pacific - 4-6-2 Forty-Niner Steam Engine  
30-1705-1 Cab No. 2492 \$459.95



Baltimore & Ohio - 4-6-2 Forty-Niner Steam Engine  
30-1706-1 Cab No. 5321 \$459.95



Lehigh Valley - 4-6-2 Forty-Niner Steam Engine  
30-1708-1 Cab No. 2055 \$459.95

# 4-6-2 Crusader



Reading - 4-6-2 Crusader Steam Engine  
30-1699-1 Cab No. 118 \$459.95

Add matching passenger sets —  
see our 2017 volume 1 catalog at  
[www.mthtrains.com](http://www.mthtrains.com)



New Haven - 4-6-2 Crusader Steam Engine  
30-1700-1 Cab No. 1410 \$459.95



Canadian National - 4-6-2 Crusader Steam Engine  
30-1701-1 Cab No. 5511 \$459.95



Halloween - 4-6-2 Crusader Steam Engine  
30-1703-1 Cab No. 1031 \$459.95



# 0-6-0 B-6 Switcher



Pennsylvania - 0-6-0 Imperial B-6 Switcher Steam Engine  
30-1709-1 Cab No. 7682 \$449.95



Long Island - 0-6-0 Imperial B-6 Switcher Steam Engine  
30-1710-1 Cab No. 170 \$449.95



Baltimore & Ohio - 0-6-0 Imperial B-6 Switcher Steam Engine  
30-1711-1 Cab No. 375 \$449.95



Union Pacific - 0-6-0 Imperial B-6 Switcher Steam Engine  
30-1712-1 Cab No. 4474 \$449.95



New Haven - 0-6-0 Imperial B-6 Switcher Steam Engine  
30-1713-1 Cab No. 2325 \$449.95



Chicago and North Western - 0-6-0 Imperial B-6 Switcher Steam Engine  
30-1714-1 Cab No. 2171 \$449.95

# Operating Hand Car



Pennsylvania - Operating Hand Car  
30-2574 \$69.95

Figures pump  
up and down  
as car moves  
along the track



Christmas - Operating Hand Car  
30-2573 \$69.95



Maintenance Of Way - Operating Hand Car  
30-2526 \$69.95



Maintenance Of Way (Orange) -  
Operating Hand Car  
30-2547 \$69.95

# 40' Woodsided Reefer



Royal Arms - 40' Woodsided Reefer  
30-78194 \$54.95



Mariposa Apples - 40' Woodsided Reefer  
30-78191 \$54.95

Makes a great complement  
for ready-to-run steam train sets.



Silver River Fruit - 40' Woodsided Reefer  
30-78192 \$54.95



Our Winner Juice - 40' Woodsided Reefer  
30-78193 \$54.95

# Operating Aquarium Car



Jellyfish - Operating Aquarium Car  
30-79546 \$79.95

**Backlit fish  
swim past  
car windows**



Tropical Fish - Operating Aquarium Car  
30-79547 \$79.95



Georgia Aquarium - Operating Aquarium Car  
30-79548 \$79.95

**View More RailKing Cars  
and Engines Online**

Go to [www.mthtrains.com](http://www.mthtrains.com)  
and click on "Catalogs"



2017 Volume 2

# Flat Car with Load



Baltimore & Ohio - Flat Car with  
'53 Ford Pickup Trucks  
30-76668 \$64.95



Long Island - Flat Car with  
'53 Ford Pickup Trucks  
30-76671 \$64.95



General Electric - Flat Car with 40' Trailer  
30-76688 \$64.95

# Accessorize Your Layout!



## See it in Action!

When you see this  icon, search for the item number on [www.mthtrains.com](http://www.mthtrains.com) to see a video of the item in action!

Create a miniature world for your railroad to serve with this wide variety of lighted RailTown™ buildings, operating accessories and O scale passengers and workers.

■ Maintenance Kit  
30-50051 \$24.95



■ Bag of Coal  
30-50005 \$4.99

■ Miscellaneous Accessories

■ Traditional Accessories

■ O Scale Accessories

*O Scale accessories are realistic O scale models, 1/48 of the actual item's size, while Traditional accessories are more toy-like in appearance and proportions.*

■ S Gauge Accessories

Keep your  
Trains Running  
Their Best



■ 7 oz. ProtoSmoke™ Fluid		
60-1045	Unscented	\$15.95
60-1046	Christmas	\$15.95
60-1047	Coal	\$15.95
60-1048	Diesel	\$15.95
60-1049	Woodburning	\$15.95

Assortment (36 pieces)

2 oz. ProtoSmoke™ Fluid Bottles  
60-1051 \$189.95

2 oz. ProtoSmoke™ Fluid Bottles		
60-1051A	Christmas	\$5.99
60-1051B	Coal	\$5.99
60-1051C	Diesel	\$5.99
60-1051D	Wood Burning (Hickory)	\$5.99
60-1051E	Coffee	\$5.99
60-1051G	Vanilla	\$5.99
60-1051H	Candy Cane	\$5.99
60-1051I	Barbeque	\$5.99
60-1051J	Pipe Smoke	\$5.99
60-1051K	Cinnamon Roll	\$5.99
60-1051L	Apple Pie	\$5.99
60-1051M	Unscented	\$5.99
60-1051N	Lemon	\$5.99



■ Operating Cooling Tower  
30-9158 \$169.95  
Measures: 9 1/2" x 8" x 12"



Operating pickup and dump mechanism for loading coal hoppers

■ Rotary Beacon  
30-9033 \$59.95  
Measures: 5" x 5" x 11 1/4"



■ Pennsylvania - 314 Die-Cast Girder Bridge  
30-12001 \$34.95  
Measures: 10" x 4 1/2" x 1 3/4"



■ Long Island - 314 Die-Cast Girder Bridge  
30-12012 \$34.95  
Measures: 10" x 4 1/2" x 1 3/4"



All-metal construction!

■ Pittsburgh & Lake Erie - 314 Die-Cast Girder Bridge  
30-12011 \$34.95  
Measures: 10" x 4 1/2" x 1 3/4"



■ North Pole - 314 Die-Cast Girder Bridge  
30-12014 \$34.95  
Measures: 10" x 4 1/2" x 1 3/4"

■ Pea Green - #580-1 Teardrop Lamp Set  
30-1079A \$19.95  
Measures: 6 3/4" Tall

All-metal lamps!



# Traditional Accessories



## All-metal lamps!

- No. 64 Street Lamp  
11-90042 \$29.95  
Measures: 6 3/4" Tall



- #262 Crossing Gate/Signal  
30-1073 \$59.95  
Measures: 9" Tall



- Black - No. 154 Highway Flashing Signal  
11-90116 \$49.95  
Measures: 9 1/8" Tall



- American Flyer #2050 Old Glory Flag Pole & Base  
11-90078 \$99.95  
Measures: 23 1/2" Tall



- Red & Gray - No. 152 Operating Crossing Gate  
11-90114 \$49.95  
Measures: 9" Tall





■ Lionel Lines - No. 98 Coal House  
11-90123 \$179.95  
Measures: 11 7/8" x 7 9/16" x 9 1/4"

Remotely dumps  
coal into waiting car

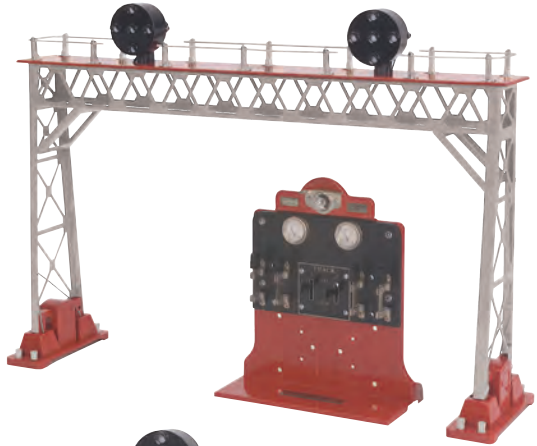

■ Silver & Red - #440 Signal Bridge & Control Panel  
11-90087 \$299.95  
Measures: 20 1/2" x 3 1/4" x 8 1/4"

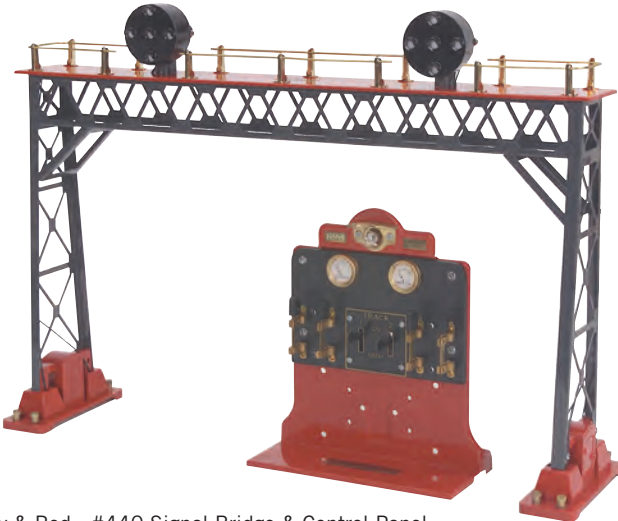

■ Gray & Red - #440 Signal Bridge & Control Panel  
11-90088 \$299.95  
Measures: 20 1/2" x 3 1/4" x 8 1/4"

# Traditional Accessories



Spinning blade "cuts" logs into planks, worker drops them into flatcar or gondola

- No. 23796 Saw Mill  
35-90001 \$119.95  
Measures: 10 1/2" x 9 1/2" x 6 1/2"



- No. 23772 Water Tower w/Bubbling Pipe  
35-90002 \$119.95  
Measures: 4 7/8" x 6" x 13"

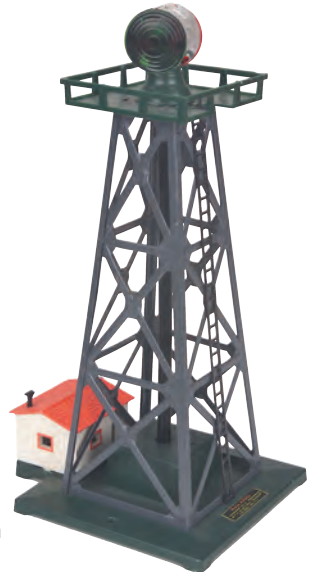

- No. 23769 Revolving Aircraft Beacon  
35-90003 \$119.95  
Measures: 4 7/8" x 6" x 13"



■ No. 23774 Floodlight Tower  
35-90004 \$119.95  
Measures: 4 7/8" x 6" x 13 3/4"

Worker loads logs  
into waiting gondola  
or flatcar



■ No. 787 Log Loader  
35-90005 \$199.95  
Measures: 10 3/4" x 9" x 8 3/4"

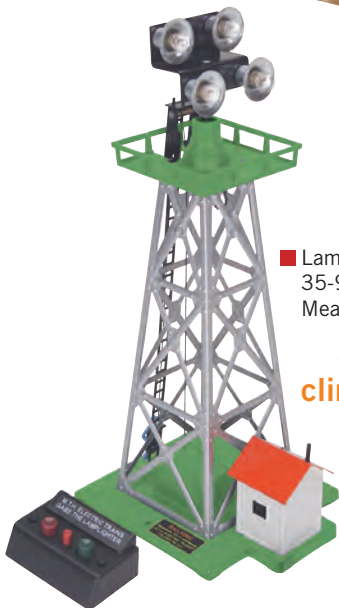

■ Lamplighter  
35-90006 \$179.95  
Measures: 4 7/8" x 6" x 13 3/4"

Gabe the Lamplighter  
climbs ladder, lights lamps  
and slides back down

■ #46 Crossing Gate and Signal  
30-11017 \$39.95  
Measures: 9" x 3 1/2" x 5 3/4"



# Scale Accessories



■ 2-Piece Generator Set  
30-50028 \$12.95



■ 2-Piece Cement LCL Container Set  
30-50029 \$14.95

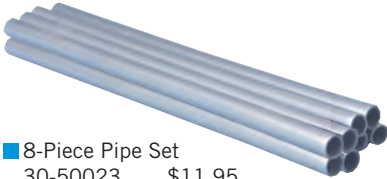

■ 8-Piece Pipe Set  
30-50023 \$11.95  
Measures: 10" Long



■ 6-Piece Barrel Set  
30-50024 \$11.95



■ MTH Steel - I-Beam 8-Piece Set  
30-50007 \$12.95  
Measures: 7 1/4" Long



■ 8-Piece Log Set  
30-50008 \$14.95  
Measures: 5" Long



■ White - Fence Set  
30-50002 \$12.95  
Measures: 16" x 13"  
House Not Included

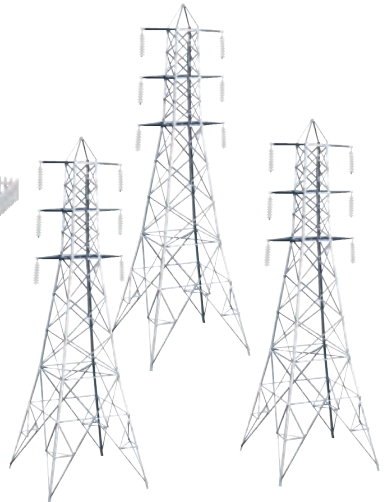

■ Hi-Tension Tower Set  
30-1056 \$79.95  
Measures: 20" x 6 3/8" x 6 3/8"



■ Black - "O" Lamp Set - Hexagonal  
 30-1062 \$34.95  
 Measures: 4" Tall



■ Black - "O" Lamp Set - Round  
 30-1078 \$34.95  
 Measures: 4" Tall



■ Black - "O" Lamp Set - Square  
 30-1079 \$34.95  
 Measures: 4" Tall

■ "O" Lamp Set - Gas Street Light  
 30-11033 \$34.95  
 Measures: 3/4" x 4 3/8"



■ "O" Lamp Set - Triple Park Light  
 30-11034 \$34.95  
 Measures: 3/4" x 4 7/16"



■ O Scale Floodlight Tower Set  
 30-11039 \$89.95  
 Measures: 3" x 1 1/8" x 13 1/2"

# Accessories



- "O" Operating Crossing Flasher Set w/Sound  
30-11014 \$69.95  
Measures: 5 1/2" x 2 1/2" x 1"

Have your trains activate these signals with a RealTrax® ITAD (p. 67) or ScaleTrax™ ITAD (p. 77)



- O Scale Operating Crossing Gate Signal Set  
30-11012 \$79.95  
Measures: 8 1/2" x 2" x 8"



- O Scale Cantilevered Signal Bridge  
30-11009 \$59.95  
Measures:  
8 1/2" x 2 1/2" x 6 1/2"



- Road Sign Set (2 Each)  
30-1087 \$14.95  
Measures: 2" Tall



- Telephone Pole Set  
30-1088 \$19.95  
Measures: 5 3/4" Tall

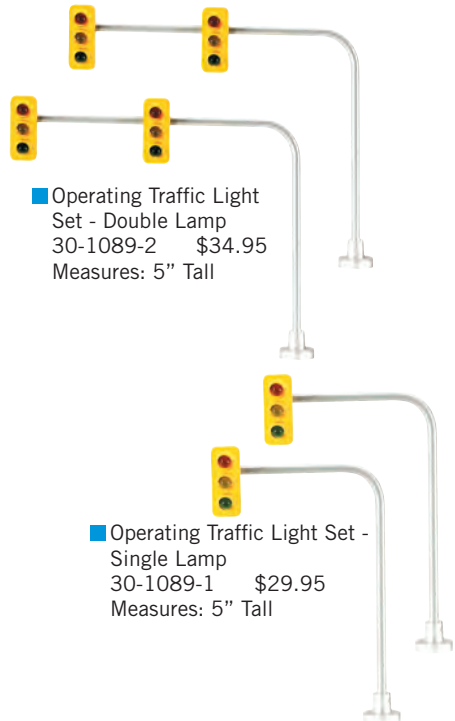

- Operating Traffic Light Set - Double Lamp  
30-1089-2 \$34.95  
Measures: 5" Tall

- Operating Traffic Light Set - Single Lamp  
30-1089-1 \$29.95  
Measures: 5" Tall



Have your trains activate these signals with a **RealTrax® ITAD (p. 67)** or **ScaleTrax™ ITAD (p. 77)**

- O Scale 3-Position Semaphore  
30-11023 \$59.95  
Measures: 7" Tall



- O Scale Flashing Barricades  
30-11021 \$39.95  
Measures: 1" x 1" x 2"

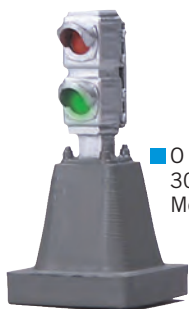

- O Scale Modern Dwarf Signal  
30-11038 \$39.95  
Measures: 1 1/2" x 1" x 2 1/8"

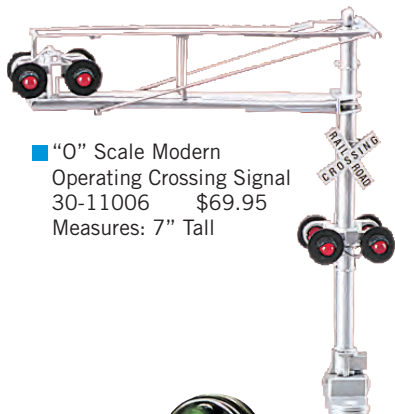

- "O" Scale Modern Operating Crossing Signal  
30-11006 \$69.95  
Measures: 7" Tall



- O Scale Dwarf Signal  
30-11011 \$29.95  
Measures: 1" x 1 7/8" x 1 3/4"

Indicates switch position when used with **ScaleTrax**, **Atlas O** or **Gargraves** switches

*Atlas O is a registered trademark of Atlas O; GarGraves is a registered trademark of GarGraves Trackage Corporation.*

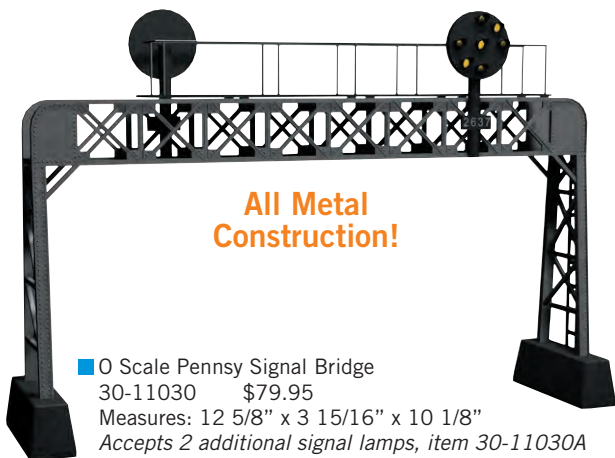

**All Metal Construction!**

- O Scale Pennsy Signal Bridge  
30-11030 \$79.95  
Measures: 12 5/8" x 3 15/16" x 10 1/8"  
Accepts 2 additional signal lamps, item 30-11030A



- O Scale Position Light Signal Lamps  
30-11030-A \$29.95  
Measures: 1 1/4" Tall  
(package of 2; fits 30-11030 Pennsy Signal Bridge)

Have your trains activate signal lamps with **RealTrax ITADs (p. 67)** or **ScaleTrax ITADs (p. 77)**

# Accessories



- Greyhound (Concord) -Die-Cast Bus  
30-50105 \$44.95  
All Buses Measure: 8" x 1 15/16" x 2 1/8"



- Pittsburgh & Lake Erie - Die-Cast Bus  
30-50106 \$44.95

**Die-Cast  
Metal!**

- Boston & Maine - Die-Cast Bus  
30-50107 \$44.95



- Philadelphia Fire Department  
- Die-Cast Fire Truck  
30-50101 \$49.95



- Braddock, Pennsylvania - Die-Cast Fire Truck  
30-50100 \$49.95  
All Fire Trucks Measure: 6 1/4" x 2 1/8" x 1 7/8"



- Cleveland Union Terminal  
- Die-Cast Fire Truck  
30-50103 \$49.95



- NYC Fire Department -  
Die-Cast Fire Truck  
30-50102 \$49.95



- Roscoe's Fireworks - Vendor Trailer  
30-50072 \$39.95  
Measures: 10" Long



- Billy Ray's Barbeque - Vendor Trailer  
30-50071 \$39.95  
Measures: 10" Long

**Opening Side Doors  
with Lighted Interior!**





Jahn's Ice Cream - Lighted Billboard  
 30-90495 \$34.95  
 Measures: 7 1/2" x 5 3/4" x 6"



Support Our Troops - Lighted Billboard  
 30-90527 \$34.95  
 Measures: 7 1/2" x 5 3/4" x 6"



Buy War Bonds - Lighted Billboard  
 30-90528 \$34.95  
 Measures: 7 1/2" x 5 3/4" x 6"



Mel's Diner - Lighted Billboard  
 30-90529 \$34.95  
 Measures: 7 1/2" x 5 3/4" x 6"

Now with  
 digital  
 sound

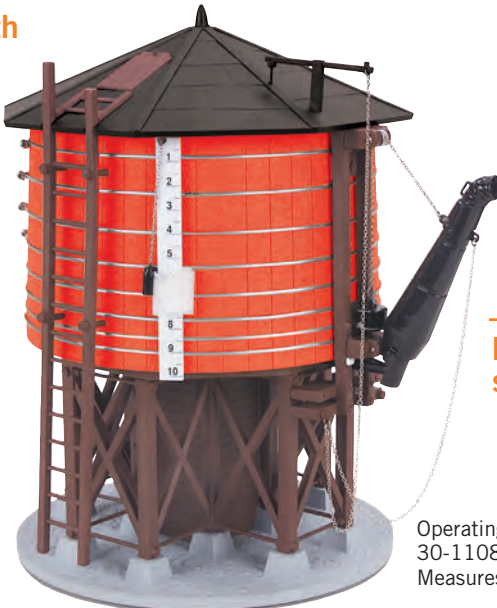

All-new  
 mechanism  
 — water spout  
 lowers to "fill"  
 steam tenders

Operating O Scale Water Tower  
 30-11086 \$139.95  
 Measures: 7 1/2" x 11" x 10 1/4"

# Figures



■ Assortment 1 - 6-Piece Figure Set  
30-11071 \$19.95



■ Assortment 1 - 6-Piece Figure Set #12  
30-11074 \$19.95



■ Assortment 2 - 6-Piece Figure Set  
30-11072 \$19.95



■ Fire House Employees - 6-Piece Figure Set #2  
30-11046 \$19.95



■ Gas Station Attendants & Patron -  
6-Piece Figure Set #1  
30-11045 19.95



■ Bus Station Employees & Patrons -  
6-Piece Figure Set #4  
30-11048 19.95



■ Diner Patrons - 6-Piece Figure Set #3  
30-11047 \$19.95



■ Miners - 6-Piece Figure Set #6  
30-11058 \$19.95



■ Cops & Robbers - 6-Piece Figure Set #5  
30-11056 \$19.95



■ Army - 6-Piece Figure Set #7  
30-11059 \$19.95



■ Fire Scene - 6-Piece Figure Set #8  
30-11060 \$19.95



■ Outdoor People - 6-Piece Figure Set  
30-11057 \$19.95



■ Workmen - 12-Piece Figure Set #3  
30-11044 \$29.95



■ Christmas - 6-Piece Figure Set  
30-11062 \$29.95



■ Passenger Figures - 12-Piece Figure Set #1  
30-11016 \$29.95



■ Railroad Employees - 12-Piece Figure Set #3  
30-11055 \$29.95



■ Subway - 12-Piece Passenger Figure Set  
30-11063 \$29.95



■ Passenger Figures - 12-Piece Figure Set #2  
30-11029 \$29.95



■ Railroad Workmen - 12-Piece Figure Set #3  
30-11066 \$29.95



■ 8-Piece Locomotive Cab Figure Set  
30-11064 \$29.95

■ Undecorated -  
120-Piece Passenger  
Figure Set  
30-11043 \$29.95



# RailTown™ Buildings



Cars drive up and park, while skaters come out and take orders



Mel's - Operating Drive-In Diner  
30-9188 \$199.95  
Measures: 21 5/8" x 9" 13 1/8"



Sequentially lighted marquee sign and interior lighting

Majestic - Movie Theater  
30-90490 \$129.95  
Measures: 16 3/4" x 13 9/16" x 9 1/16"

Fireman slides down pole, door opens and fire truck pulls out with siren blaring



Engine Company 49 - Operating Firehouse  
30-9157 \$189.95  
Measures: 16 5/8" x 15 3/8" x 12 3/8"



The Old Reading Brewing Company -  
Operating Freight Platform  
30-90190 \$64.95  
Measures: 10" x 3 1/2" x 4"

Passengers or freight  
disappear when  
train departs



Middletown Station -  
Operating Freight Platform  
30-9184 \$64.95  
Measures: 10" x 3 1/2" x 4"

Attendant with hose  
descends to fill  
waiting tank car



Operating  
Lights

Shell - Operating Storage Tank Station  
30-9190 \$179.95  
Measures: 16 1/8" x 5" x 8 1/8"

# RailTown Buildings



Mobil - Tank Filling Station  
30-90419 \$59.95  
Measures: 16 1/8" x 5" x 8 1/8"



Esso - Tank Filling Station  
30-90405 \$59.95  
Measures: 16 1/8" x 5" x 8 1/8"



Sunoco - Operating Gas Station  
30-9195 \$179.95  
Measures: 15" x 11" x 6 3/4"



South Side - Country Passenger Station  
30-90517 \$69.95  
Measures: 18 5/8" x 7 3/8" x 6 5/8"

**Buildings feature  
interior lighting!**



North Side - Country Passenger Station  
30-90516 \$69.95  
Measures: 18 5/8" x 7 3/8" x 6 5/8"



Madison - Country Passenger Station  
30-90559 \$69.95  
Measures: 18 5/8" x 7 3/8" x 6 5/8"

Washington - Country Passenger Station  
w/Operating Christmas Lights  
30-90549 \$89.95  
Measures: 18 5/8" x 7 3/8" x 6 5/8"



North Pole - Country Passenger Station  
w/Operating Christmas Lights  
30-90525 \$89.95  
Measures: 18 5/8" x 7 3/8" x 6 5/8"

# RailTown Buildings



Light Gray - 3-Story Town House #1  
30-90542 \$49.95  
Measures: 4 1/8" x 6 3/4" x 7 11/16"



Pale Yellow - 3-Story Town House #1  
30-90543 \$49.95  
Measures: 4 1/8" x 6 3/4" x 7 11/16"



Cream & Brown - 3-Story Town House #3  
30-90510 \$49.95  
Measures:  
4 1/8" x 6 3/4" x 7 11/16"



Red & Gray - 3-Story Town House #3  
30-90509 \$49.95  
Measures: 4 1/8" x 6 3/4" x 7 11/16"



Tan - 3-Story Town House #2  
30-90544 \$49.95  
Measures: 4 1/8" x 6 3/4" x 7 11/16"

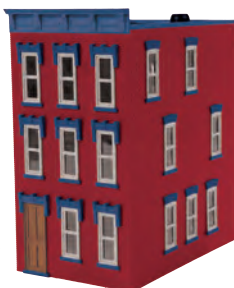

Light Tuscan Brick - 3-Story  
Town House #3  
30-90376 \$49.95  
Measures:  
4 1/8" X 6 3/4" X 7 11/16"

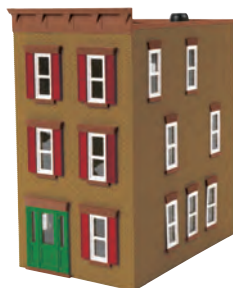

Tan & Red - 3-Story Town House #2  
30-90508 \$49.95  
Measures: 4 1/8" x 6 3/4" x 7 11/16"





Schitz Plumbing Service - Road Side Stand  
 30-90538 \$49.95  
 Measures: 8 1/2" x 5 7/16" x 4 1/4"



Jurassic Pork Bar-B-Que - Road Side Stand  
 30-90539 \$49.95  
 Measures: 8 1/2" x 5 7/16" x 4 1/4"



Dirty Hoe Garden Center - Road Side Stand  
 30-90537 \$49.95  
 Measures: 8 1/2" x 5 7/16" x 4 1/4"



Ye Olde Christmas Shop - Road Side Stand w/  
 Operating Christmas Lights  
 30-90563 \$69.95  
 Measures: 8 1/2" x 5 7/16" x 4 1/4"

**Buildings feature  
 interior lighting!**



Norman's Taxidermy - Corner Building  
 w/Blinking Sign  
 30-90475 \$59.95  
 Measures: 9 7/8" x 7 7/16" x 7 1/16"



Gray & Black - Police Station  
 30-9099 \$89.95  
 Measures: 13 1/4" x 8 3/8" x 10"



Bank w/Coin Slot  
 30-90550 \$89.95  
 Measures: 9 1/2" x 17 15/16" x 9 1/8"

# RailTown Buildings

Corner stores feature  
lighted marquee signs



Squeeky's Auto Parts - Single Story Corner Store  
30-90448 \$59.95  
Measures: 10 3/8" x 8 3/8" x 6 1/4"



Downtown Hobby - Single Story Opposite  
Corner Store  
30-90451 \$59.95  
Measures: 10 3/8" x 8 3/8" x 6 1/4"

Buildings feature  
interior lighting!



The Codfather Fish House - 3-Story City  
Building w/Fire Escape & Blinking Sign  
30-90541 \$79.95  
Measures: 12 3/4" x 6 5/16" x 9 3/16"



Hubie Skriemen D.D.S. - 3-Story City  
Building w/Fire Escape & Blinking Sign  
30-90155 \$79.95  
Measures: 12 3/4" x 6 5/16" x 9 3/16"



Wok This Way Chinese Restaurant -  
3-Story City Building w/Fire Escape &  
Blinking Sign  
30-90540 \$79.95  
Measures: 12 3/4" x 6 5/16" x 9 3/16"

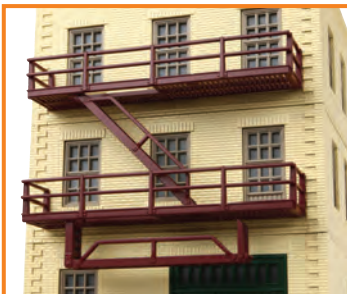



Vinyl Resting Place Music - 4-Story Building  
 30-90558 \$69.95  
 Measures: 9 1/16" x 8 11/16" x 13 9/16"



Doolittle & Daily Retirement Apartments - 4-Story Building  
 30-90347 \$69.95  
 Measures: 9 1/16" x 8 11/16" x 13 9/16"



Ditcher Quick & Hyde Divorce Lawyers - 4-Story Building  
 30-90557 \$69.95  
 Measures: 9 1/16" x 8 11/16" x 13 9/16"



Grand Hotel - 5-Story Hotel w/Blinking Sign  
 30-90556 \$79.95  
 Measures: 12 3/4" X 6 5/16" X 13 1/2"

**Buildings feature interior lighting!**

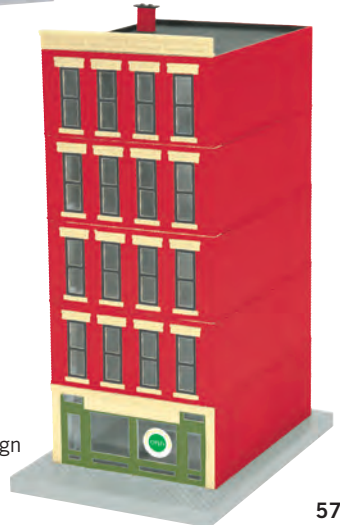

Algonquin Hotel - 5-Story Hotel w/Blinking Sign  
 30-90555 \$79.95  
 Measures: 12 3/4" X 6 5/16" X 13 1/2"

# RailTown Buildings

Dark Red Brick - Passenger Station  
w/dual Platforms  
30-90094 \$109.95  
Measures: 39" x 10 1/2" x 8 1/2"



Gray w/Green Roof - Passenger Station Platform  
30-90315 \$24.95  
Measures: 10" x 3 1/2" x 4"



Brown w/Gray roof - Passenger  
Station Platform  
30-9006 \$24.95  
Measures: 10" x 3 1/2" x 4"



Elevated Station Platform  
30-90027 \$34.95  
Measures: 13 1/2" x 5 1/2" x 4"

Red & Black - Country Freight Station  
30-90004 \$39.95  
Measures: 9" x 5 1/2" x 5"



Cream & Dark Gray - Power Station  
30-90003 \$34.95  
Measures: 4 1/4" x 4 1/8" x 3 7/8"



North Pole - Power Station  
30-90535 \$34.95  
Measures: 4 1/4" x 4 1/8" x 3 7/8"



#5 Country Church  
 30-90518 \$39.95  
 Measures: 7 7/8" x 4 5/8" x 10 9/16"



Druggist - 2-Story False Front Building  
 30-90560 \$59.95  
 Measures: 6 1/2" x 8" x 8 5/8"



Gray & Maroon - Trakside  
 Yard Tower  
 30-90006 \$39.95  
 Measures: 4" x 4" x 7 1/2"

**Buildings feature  
 interior lighting!**

North Pole - Trakside  
 Yard Tower  
 30-90536 \$39.95  
 Measures: 4" x 4" x 7 1/2"



S&D Dry Goods and Provisions -  
 2-Story False Front Building  
 30-90164 \$54.95  
 Measures: 6 1/2" x 8" x 8 5/8"



Brown & Black -  
 Elevated Gate Tower  
 30-9097 \$29.95  
 Measures:  
 3 1/2" x 2 1/2" x 5 3/4"

# RailTown Buildings



King Soda - Barn  
30-90498 \$79.95  
Measures: 16 1/2" x 18 3/4" x 9 1/2"



Support Our Troops - Barn  
30-90533 \$79.95  
Measures: 16 1/2" x 18 3/4" x 9 1/2"



Hood's Dairy - Barn  
30-90534 \$79.95  
Measures: 16 1/2" x 18 3/4" x 9 1/2"



Red & Brown - Barn  
30-90502 \$79.95  
Measures: 16 1/2" x 18 3/4" x 9 1/2"

**Buildings feature  
interior lighting!**



Gray Stone - Granary  
30-90188 \$69.95  
Measures: 10 1/4" x 7" x 11 1/8"



Country Bingo Hall  
30-90466 \$39.95  
Measures: 9 1/4" x 6 1/8" x 5"



Yellow with Blue Shutters - #6 Farm House  
30-90553 \$49.95  
Measures: 7 1/2" x 7 1/2" x 7"



Red & Green - #4 Country House  
30-90513 \$49.95  
Measures: 9 5/8" x 5" x 7"



Blue with Green Shutters - #6  
Farm House  
30-90554 \$49.95  
Measures: 7 1/2" x 7 1/2" x 7"

**Buildings feature  
interior lighting!**



#6 Farm House w/Operating Christmas Lights  
30-90548 \$79.95  
Measures: 7 1/2" x 7 1/2" x 7"



#6 Farm House w/Operating Christmas Lights  
30-90547 \$79.95  
Measures: 7 1/2" x 7 1/2" x 7"



#4 Country House w/Operating Christmas  
Lights - Light Gray and Teal  
30-90545 \$79.95  
Measures: 9 5/8" x 5" x 7"



#4 Country House w/Operating Christmas  
Lights - Dark Blue and Brown  
30-90546 \$79.95  
Measures: 9 5/8" x 5" x 7"

# RailTown Buildings

**Buildings  
Feature  
Interior  
Lighting!**



Green - Row House #2  
30-90551 \$44.95  
Measures: 8 1/2" x 4 5/8" x 7"



Red & Gray - Row House #2  
30-90552 \$44.95  
Measures: 7 1/2" x 7 1/2" x 7"

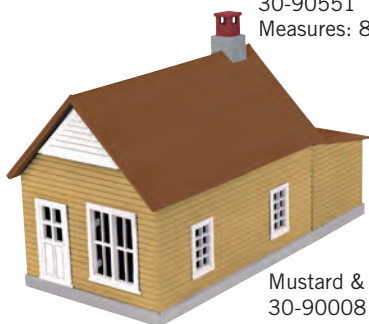

Mustard & Red - Work House #1  
30-90008 \$34.95  
Measures: 8 5/8" x 4 7/16" x 4 7/8"



Blue & White - Telephone Shanty  
30-90002 \$12.95  
Measures: 2" x 1 5/16" x 2 11/16"



Gray & White - Out House  
30-90001 \$12.95  
Measures:  
1 3/16" x 1 5/16" x 2 7/16"



Turquoise & White - Stainless Mobile Home  
30-90531 \$29.95  
Measures: 7 1/8" x 2 3/8" x 2 3/4"



Salmon & White - Stainless Mobile Home  
30-90532 \$29.95  
Measures: 7 1/8" x 2 3/8" x 2 3/4"



Stainless - Stainless Mobile Home  
30-90530 \$29.95  
Measures: 7 1/8" x 2 3/8" x 2 3/4"



# Trucks and Couplers

## 3-Rail



RailKing 3-Rail Bettendorf Freight Car  
Two-Truck Pack  
30-89001 \$19.95  
RailKing 3-Rail Roller Bearing Freight Car  
Two-Truck Pack  
30-89002 \$19.95



Premier 3-Rail Bettendorf Freight Car  
Two-Truck Pack  
20-89003 \$24.95  
Premier 3-Rail Roller Bearing Freight Car  
Two-Truck Pack  
20-89004 \$24.95

## Premier 2-Rail



2-Rail Bettendorf Freight Car Two-Truck Pack  
20-89001 \$24.95  
2-Rail Roller Bearing Freight Car  
Two-Truck Pack  
20-89002 \$24.95  
2-Rail Lightweight Passenger Car  
Two-Truck Pack  
20-89007 \$29.95



2-Rail Heavyweight Passenger Car  
Two-Truck Pack  
20-89014 \$29.95  
2-Rail Bettendorf Caboose Two-Truck Pack  
20-89015 \$24.95  
2-Rail Roller Bearing Caboose Two-Truck Pack  
20-89016 \$24.95  
2-Rail 64' Woodsided Passenger Car Two-Truck Pack  
20-89012 \$29.95



Proto-Scale 3-2™ 4-Wheel  
Truck Scale Wheel Set  
20-89005 \$39.95  
Proto-Scale 3-2 6-Wheel Truck  
Scale Wheel Set  
20-89006 \$59.95  
Proto-Scale 3-2 4-Wheel Truck  
Hi-Rail Wheel Set  
20-89008 \$39.95  
Proto-Scale 3-2 6-Wheel Truck  
Hi-Rail Wheel Set  
20-89009 \$59.95



No. 804 Kadee® Coupler & Draft Gear Box  
Set (Plastic)  
20-89018 \$4.75  
No. 805 Kadee Coupler & Draft Gear Box  
Set (Metal)  
20-89019 \$4.75

## End-Of-Train-Device Roller Bearing Freight Truck



Proto-Sound 2.0 10-Pin Wireless Drawbar Set (Sizes: 30mm, 35mm, 40mm)  
20-89011 \$29.95  
Proto-Sound 3.0 6-Pin Wireless Drawbar Set 1 (Sizes: 25mm, 30mm, 45mm)  
20-89020 \$29.95  
Proto-Sound 3.0 6-Pin Wireless Drawbar Set 2 (Sizes: 30mm, 35mm, 50mm)  
20-89021 \$29.95

Flashing  
Red LED



White End-of-Train-Device Roller Bearing Freight Truck  
20-89013 \$24.95  
Yellow End-of-Train-Device Roller Bearing Freight Truck  
20-89010 \$24.95

# O Gauge RealTrax®

## Rugged - Realistic - Reliable

At M.T.H. we believe a track system should allow your model railroad empire to grow. The RealTrax system includes 72 different components for maximum expansion capabilities. You'll find bridges, curves of all sizes, elevated and graduated trestles, crossovers, and every straight and curved configuration you'll need to create your own model railroad empire. And every piece of RealTrax is rugged, realistic, and reliable so you can have fun running your trains.



## Rugged

Because most toy train empires begin on a carpet or floor, RealTrax is designed to hold up to the rigors of childhood play. Strong snap-together connections make it easy to assemble or change a layout in minutes. And the built-in roadbed helps keep dirt on the floor away from the wheels and gears of your trains.



## Realistic

With its realistic crosssties and ballasted roadbed, RealTrax looks like the mainline track used by heavy freights and high-speed passenger trains. Unlike older O gauge track with a round cross section, RealTrax uses flat-top "T"-rail like a real railroad.

## Reliable

Nickel silver rail ensures that RealTrax will never rust. Spring-loaded phosphor bronze contacts provide superior electrical connections between track sections. The contacts are spring loaded to maintain a solid connection over time and are highly resistant to corrosion of any kind.

RealTrax switches feature the same durable construction as regular RealTrax sections and utilize long-lasting switch motors that provide precise throws every time. The reversible motor mechanism quickly snaps onto the other side of the switch if space is a problem. No disassembly of the switch is required! Lighted switch controllers allow you to throw a switch remotely from a distance, and lights on the controller indicate which direction the switch is thrown - green for straight and red for curved.

\*Number indicates circle diameter: 0-31 curves, for example, make a 31" circle

IT TAKES **EIGHT 0-31 CURVES** TO MAKE A CIRCLE.\*  
IT TAKES **TWELVE 0-42 CURVES** TO MAKE A CIRCLE.  
IT TAKES **TWELVE 0-54 CURVES** TO MAKE A CIRCLE.  
IT TAKES **SIXTEEN 0-72 CURVES** TO MAKE A CIRCLE.  
IT TAKES **SIXTEEN 0-82 CURVES** TO MAKE A CIRCLE.



RealTrax - 10" Ground Track  
40-1068-2 \$9.99



RealTrax - 10" Straight Track Section  
40-1001 \$4.99



RealTrax -  
5.5" Track Section  
40-1012 \$4.49



RealTrax -  
5.0" Track Section  
40-1016 \$4.49



RealTrax -  
4.25" Track Section  
40-1017 \$4.49



RealTrax -  
3.5" Track Section  
40-1018 \$4.49

## Crossover & Operating Sections



RealTrax -  
90° Crossover Track  
40-1006 \$24.95

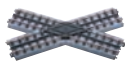

RealTrax -  
45° Crossover Track  
40-1007 \$24.95



RealTrax -  
Operating Track Section  
40-1008 \$29.95  
(activates M.T.H., Lionel and other brands of operating cars)



RealTrax - Adapter Track Section  
40-1011 \$8.99

Tubular Track Not Included

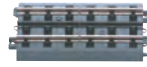

RealTrax - 5" Insulated Straight Track Section Set  
40-1029 \$9.99

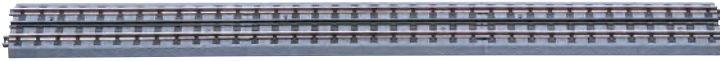

RealTrax - 30" Straight Track Section  
40-1019 \$13.99



RealTrax -  
O-31 Half Curve Track  
40-1022 \$4.49



RealTrax -  
O-42 Half Curve Track  
40-1045 \$4.99



RealTrax -  
O-54 Half Curve Track  
40-1057 \$5.49



RealTrax -  
O-72 Half Curve  
Track Section  
40-1049 \$5.49



RealTrax -  
O-31 Curved Track Section  
40-1002 \$4.99

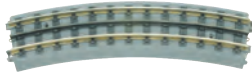

RealTrax -  
O-42 Curved Track Section  
40-1042 \$4.99



RealTrax -  
O-54 Curved Track Section  
40-1054 \$5.99

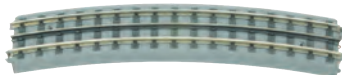

RealTrax - O-72 Curved Track Section  
40-1010 \$6.99



RealTrax - O-82 Curved Track Section  
40-1082 \$6.99

## Switches

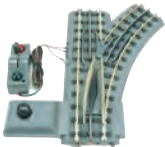

RealTrax -  
O-31 Switch (RH)  
40-1004 \$69.95

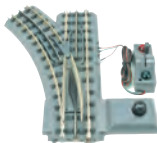

RealTrax -  
O-31 Switch (LH)  
40-1005 \$69.95

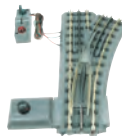

RealTrax -  
O-42 Switch (RH)  
40-1043 \$74.95



RealTrax -  
O-42 Switch (LH)  
40-1044 \$74.95



RealTrax -  
O-54 Switch (LH)  
40-1056 \$79.95



RealTrax -  
O-72 Switch (LH)  
40-1021 \$89.95

RealTrax -  
O-54 Switch (RH)  
40-1055 \$79.95

RealTrax -  
O-72 Switch (RH)  
40-1020 \$89.95



RealTrax -  
O-72 Wye Switch  
40-1068 \$89.95

# O Gauge RealTrax®



O Girder Bridge w/Operating White Lights - Silver  
40-1118 \$59.95  
Measures: 10" x 5 1/8" x 9"



O Steel Arch Bridge w/Operating White Lights - Silver  
40-1117 \$149.95  
Measures: 30" x 5 1/8" x 14"

**\*Bridges now compatible with Lionel® FasTrack™**

O Girder Bridge - Rust  
40-1104 \$34.95  
O Girder Bridge - Silver  
40-1102 \$34.95  
O Girder Bridge - Black  
40-1106 \$34.95  
Measures: 10" x 5 1/8" x 9"

O 2-Track Girder Bridge - Rust  
40-1110 \$44.95  
O 2-Track Girder Bridge - Silver  
40-1108 \$44.95  
O 2-Track Girder Bridge - Black  
40-1112 \$44.95  
Measures: 10" x 9" x 9"



O 2-Track Steel Arch Bridge - Rust  
40-1109 \$119.95  
O 2-Track Steel Arch Bridge - Silver  
40-1107 \$119.95  
O 2-Track Steel Arch Bridge - Black  
40-1111 \$119.95  
Measures: 30" x 9" x 14"



**Includes Flashing Bridge Beacon**

O Steel Arch Bridge - Rust  
40-1103 \$79.95  
O Steel Arch Bridge - Silver  
40-1101 \$79.95  
O Steel Arch Bridge - Black  
40-1105 \$79.95  
Measures: 30" x 5 1/8" x 14"



O Subway Trestle Bridge  
40-1148 \$34.95  
Measures: 10" x 5 1/8" x 8"



Tunnel Portal - Double Track  
40-9015 \$19.95  
Inside Measures: 7 1/2" x 5 5/8"



Tunnel Portal - Single Track  
40-9014 \$14.95  
Inside Measures: 4 1/4" x 5 5/8"



8 Piece Elevated Subway Trestle Set

40-1047 \$39.95

8 Piece Elevated Subway Trestle Set For Lionel Fastrack

40-1157 \$39.95

Measures: 6 1/2" High

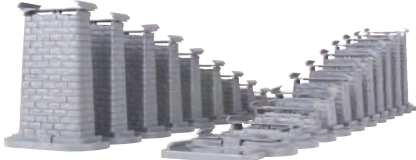

RealTrax - 24-Piece Graduated Trestle System

40-1033 \$64.95

RealTrax - 24-Piece Graduated Trestle System For Lionel Fastrack

40-1113 \$64.95

## 100 WATT POWER SUPPLY!

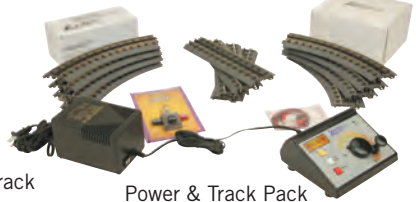

Power & Track Pack

40-1071 \$169.95



RealTrax - 8-Piece Elevated Trestle System

40-1034 \$39.95

RealTrax - 8-Piece Elevated Trestle System For Lionel Fastrack

40-1134 \$39.95

Measures: 6 1/2" High



RealTrax - Lighted Lockon

40-1003 \$6.99

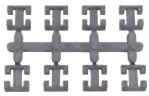

RealTrax - Track Clips (24)

40-1041 \$7.95



RealTrax - Non-Slip Track Pads (50/pack)

40-1046 \$7.95



RealTrax - Lighted Bumper

40-1024 \$14.95



RealTrax - Track Activation Device (I.T.A.D.)

40-1028 \$29.95

## Layout Builders

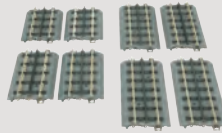

RealTrax - Layout Builder (8 Pcs)

40-1023 \$34.95

(Contains: (2) 3.5" Half Tracks, (2) 4.25" Half Tracks, (2) 5.0" Half Tracks, (2) 5.5" Half Tracks)

RealTrax - Figure 8 Layout Builder

40-1025 \$69.95

(Contains: (4) 0-31 Curves, (4) 10" Straights, (1) Lighted Lockon, (1) 90 Degree Crossover)

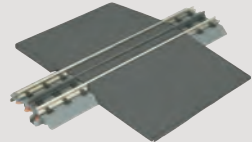

RealTrax - Grade Crossing

40-1009 \$9.95

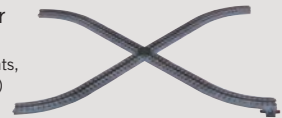

RealTrax - Right Hand Track Siding Layout Builder

40-1027 \$99.95

(Contains (1) Right-Hand 0-31 Switch, (4) 10" Straights, (1) 0-31 Curve, (1) RealTrax™ Bumper)

RealTrax - Left Hand Track Siding Layout Builder

40-1026 \$99.95

(Contains (1) Left-Hand 0-31 Switch, (4) 10" Straights, (1) 0-31 Curve, (1) RealTrax Bumper)



(Contains (1) 0-72 Wye Switch, (6) 10" Straights, (2) Lighted Bumpers, (2) 0-72 Half Curves)

RealTrax

0-72 Wye Switch Spur Layout Builder

40-1069 \$149.95

# RealTrax® Layouts

## STORY OF OIL 13x23 FEET

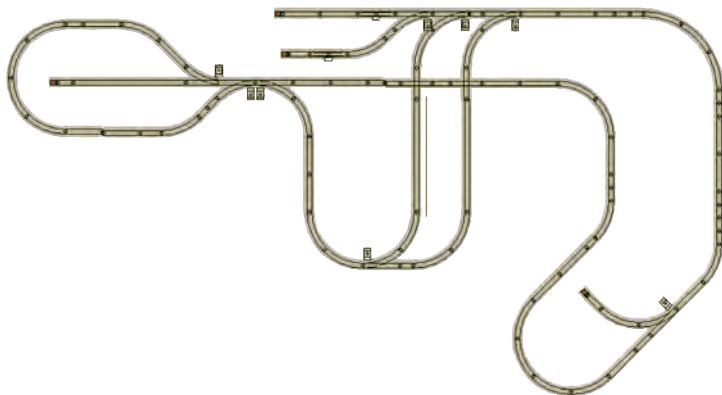

This layout is a good example of how a loop can be elaborated until it doesn't look like a loop anymore. This track plan also thinks like a point to point, because we are following the entire cycle of the oil business, from the oil well to the gas pump and beyond. On the left we have the oil fields and the storage tanks for the freshly extracted crude oil. At the storage tank station, you can fill tank cars with black gold. These tank cars will be dropped off at the oil refinery in the middle of the layout. You'll need to build the refinery yourself, but it's a relatively easy model to build. Refineries are basically flat-roof metal buildings surrounded by LOTS of pipes and storage tanks. Empty tin cans, tin foil, and lots of flexible drinking straws colored silver with a paint marker will create the effect quite nicely.

Behind the refinery is a plastics factory. Here you drop tankers of oil on one track and carry away covered hoppers full of plastic pellets from the other track.

Finally, we pass into a suburban area with houses and a gas station. This gas station is unusual in that it receives its gasoline in a tank car that you leave on the siding in the back, rather than having it trucked in. The operating gas station and car wash add the final touch of delivering the gas to consumers!

### TRACK REQUIRED

- (38) MTH 40-1001 10 inch straight
- (7) MTH 40-1016 5.0 inch straight
- (3) MTH 40-1019 30 inch straight
- (4) MTH 40-1024 track bumper
- (5) MTH 40-1043 0-42 lefthand switch
- (3) MTH 40-1044 0-42 righthand switch
- (40) MTH 40-1042 0-42 curve
- (6) MTH 40-1017 4.25 inch straight
- (2) MTH 40-1006 90° crossing
- (6) MTH 40-1012 5.5 inch half straight
- (2) MTH 40-1008 uncoupling track
- (4) MTH 40-1018 3.5 inch straight

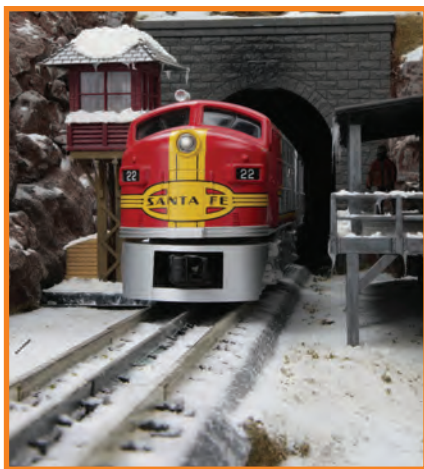

## ACTION IN 3x6 FEET

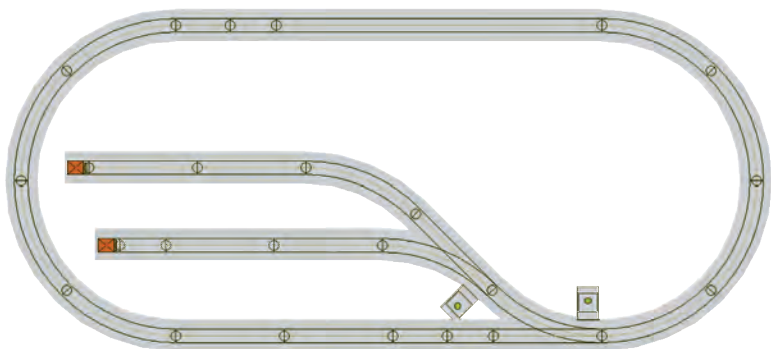

Here's a layout small enough to fit in a bedroom, yet still big enough to give you the fun of real railroading. The track plan is basically a loop, but the small yard enables you to have passengers and switching operations, in addition to continuously running trains. With detailed scenery, this layout makes a pleasing and enjoyable railroad for the modeler with limited space.

### TRACK REQUIRED

- (9) MTH 40-1002 0-31 curve
- (1) MTH 40-1019 30 inch straight
- (3) MTH 40-1017 4.25 inch straight
- (2) MTH 40-1016 5.0 inch straight
- (1) MTH 40-1004 O31 righthand switch
- (1) MTH 40-1005 O31 lefthand switch
- (6) MTH 40-1001 10 inch straight
- (2) MTH 40-1024 track bumper

## SPACE

The most important limitation most railroads encounter is space. Does your house have a spare room, basement, or attic? These are by far the most popular places for model railroads, because they use space that nobody else in the house wants. That means your railroad can be set up permanently, with appropriate lighting, backgrounds, seating, and even a little workbench for assembling buildings, painting cars and so on. If you are lucky to have such a space available, get a tape measure and plot out how large the room is. The size and shape of the room will help define your railroad.



# RealTrax® Layouts

## DOUBLE TRACK IN 4x8 FEET

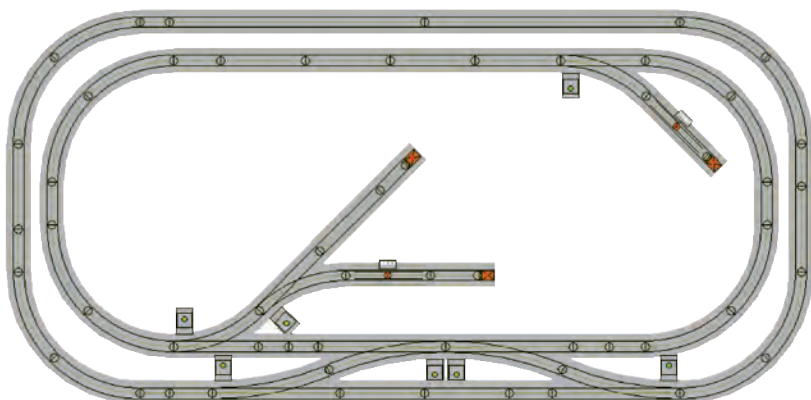

This layout strikes a nice balance between action and scenery. Create a contrast between town and country by using scenic separation to stretch the 4x8 feet into a whole countryside. Your town might have an attractive station and a coal loader, as well as a water tank for your engines. Add a lake and a farm on the opposite shore, with a siding for picking up milk cans in the morning and unloading empties in the evening. And with two tracks, you can run two trains at a time, ensuring constant movement.

### SHAPE

Often, instead of getting an entire room or basement to itself, a railroad can acquire several small adjoining areas, spread across one or more rooms. Perhaps the main line will fill the corner of the basement rumpus room, with storage yard tracks running through a tunnel in the wall and onto a shelf over the washer and dryer. Perhaps the line can fill shelves along two walls of a room.

These kinds of opportunities can radically change the track plan of your railroad. In addition, these sorts of small intrusions into other spaces can provide areas of expansion for a more conventional train table line that needs room to grow.

### TRACK REQUIRED

- (16) MTH 40-1002 0-31 curve
- (1) MTH 40-1005 031 lefthand switch
- (2) MTH 40-1004 031 righthand switch
- (4) MTH 40-1018 3.5 inch straight
- (9) MTH 40-1001 10 inch straight
- (2) MTH 40-1012 5.5 inch half straight
- (3) MTH 40-1017 4.25 inch straight
- (6) MTH40-10165.0inchstraight
- (2) MTH 40-1019 30 inch straight
- (2) MTH40-1020 072 right hand switch
- (2) MTH 40-1021 072 lefthand switch
- (3) MTH 40-1024 track bumper
- (2) MTH 40-1008 uncoupling track
- (2) MTH 40-1014 10 inch girder bridge

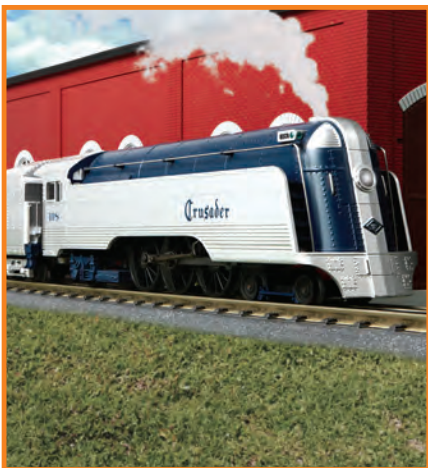



## MAX ACTION IN 4x8 FEET

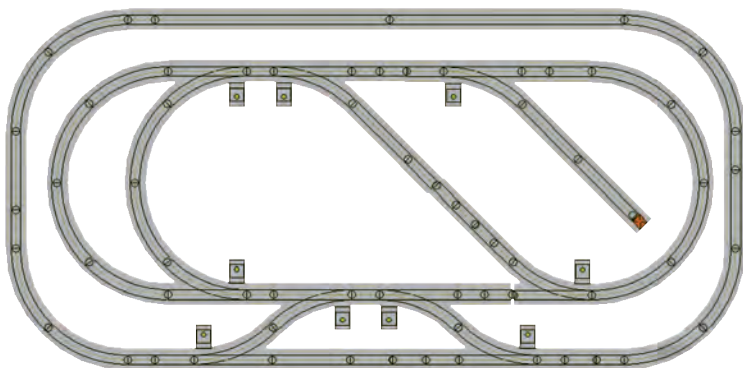

Just as the name implies, this track plan really packs in the activity! As many tracks as will fit, plus all the operating accessories to keep them humming, make this a great plan for modelers who like to keep their freight trains busy. With two tracks, you can keep a train rolling at all times while another works its way around, serving the many industries in this town. Accessorize this layout with lighted RailTown buildings and an operating cooling tower, water tower, freight transfer dock, or crossing gates, and you and your visitors will have plenty to see and do!

### TRACK REQUIRED

- (18) MTH 40-1002 0-31 curve
- (2) MTH 40-1019 30 inch straight
- (6) MTH 40-1001 10 inch straight
- (5) MTH 40-1016 5.0 inch straight
- (6) MTH 40-1004 031 righthand switch
- (16) MTH 40-1018 3.5 inch straight
- (2) MTH 40-1012 5.5 inch half straight
- (3) MTH 40-1017 4.25 inch straight
- (3) MTH 40-1005 031 lefthand switch
- (1) MTH 40-1024 track bumper

## ROOM TO OPERATE

The kinds of railroad action you most enjoy will also influence your layout. Do you like lots of switching cars in the yard? Then your layout will feature a big yard, which often works well on a shelf. Do you want long mainline runs through rural terrain? Then your layout will probably require a twice-around loop with mountains, trees, or other view blockers to make the trip look longer.



# RealTrax® Layouts

## TWICE AROUND 4x8 FEET

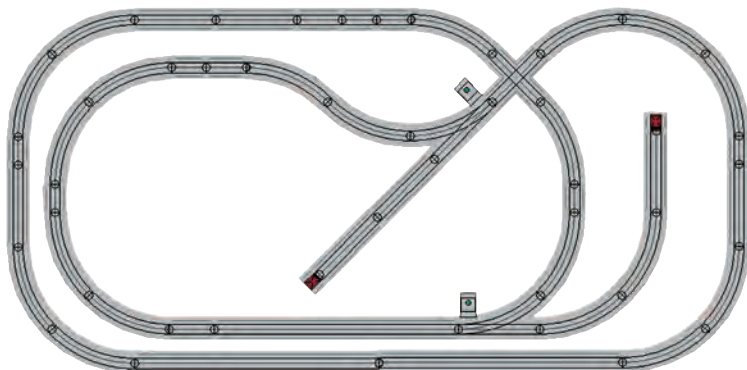

One way of making your layout seem bigger is to have the trains make two trips around the table before they get back to the starting point. This track plan does just that. It also includes a couple of sidings for you to pick up and drop off cars. If you have more room and can put in more straight track, this plan can become very realistic.

### TRACK REQUIRED

- (4) MTH 40-1018 3.5 inch straight
- (20) MTH 40-1002 0-31 curve
- (3) MTH 40-1019 30 inch straight
- (7) MTH 40-1001 10 inch straight
- (1) MTH 40-1006 90° cross
- (3) MTH 40-1017 4.25 inch straight
- (2) MTH 40-1012 5.5 inch half straight
- (1) MTH 40-1005 O31 lefthand switch
- (1) MTH 40-1004 O31 righthand switch
- (1) MTH 40-1016 5.0 inch straight
- (2) MTH 40-1024 track bumper

## THE SCENIC ROUTE

The style of scenery you want will also determine the shape of your layout. Mountains and bridges will require more up and down space than fields and forests. A desert will make a big open, flat area that may require a mountain to hide the other end of the track. Cities can look great and provide a real contrast with rural scenery, but buildings do take up considerable space. Tracks move differently through different kinds of terrain, with a mountain logging railroad having a very different track plan from the Union Pacific roaring across the Nebraska cornfields.



## WILD WEST/CIVIL WAR 10x10 FEET

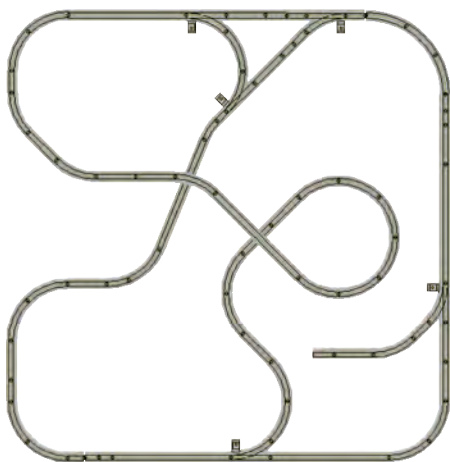

This is an old-time layout which incorporates several interesting features. The most challenging is the helix curve around the mountain, where the train passes over itself. This not only gives you a cool over/under effect, but it captures the rugged flavor of early railroads clawing their way through the mountains to open up the country. This will require a relatively steep grade, but since 1860s trains were short and pulled by little 4-4-0 locomotives like the one shown on page 17, you shouldn't have trouble operating it. You'll want to be sure to use RailKing engines with Proto-Sound 3.0, so that you have the speed control, otherwise you might have some runaway trains!

Another important detail is the arrangement of track switches up by the town. This arrangement is called a "wye" because it resembles the letter "Y." It's important because a wye enables you to turn trains around, so they can face either direction. It's sort of like backing your car into a driveway to change directions on a street. A wye can be a helpful addition to all sorts of track plans and the one shown here is about as compact as you can build.

To keep the trains busy, there is also a

mine on the side of the mountain, served by the siding in the lower right corner. The water tank makes sure the trains don't get stuck out in the wilderness, miles from town. And the track from the bottom of the wye passes through a tunnel in the mountain, which is always a popular sight with visitors.

If you want to represent the Wild West, you can paint your scenery in desert shades of orange and brown, with little cacti and tumbleweeds. For a Civil War scene, cover the mountains with pine trees, and fill the fields with grass, farm crops, and soldiers. In the West, the mine might be producing gold or silver; in the Civil War, it's probably digging coal.

### TRACK REQUIRED

- (24) MTH 40-1002 0-31 curve
- (6) MTH 40-1019 30 inch straight
- (3) MTH 40-1005 031 lefthand switch
- (14) MTH 40-1001 10 inch straight
- (2) MTH 40-1004 031 righthand switch
- (5) MTH 40-1012 5.5 inch half straight
- (3) MTH 40-1042 O42 curve
- (4) MTH 40-1018 3.5 inch straight
- (4) MTH 40-1017 4.25 inch straight
- (2) MTH 40-1022 0-31 half curve
- (2) MTH 40-1016 5.0 inch straight

# RealTrax® Catenary



The RealTrax® Catenary System and RealTrax Catenary Expander are O Gauge's only ready-to-use catenary systems that setup in minutes! Simply position the authentic-looking catenary poles and wires per your layout's requirements, and enjoy the realism of a fully functional easy-to-use catenary system.

#### 8-Piece System Features:

- Compatible with RealTrax® or any other O-Gauge Track
- Removable RealTrax® Lock-On Base Connection
- Thumbscrew Power Terminals
- Adjustable Pole Spacing
- Adjustable Messenger Beam Height
- Adjustable Wire Positioning
- Base Mounting Screws Included



RealTrax - 8-Piece Catenary System  
40-1035      \$149.95

RealTrax - 4-Piece Add-On Catenary System  
40-1036      \$79.95



Catenary Hardware Pack  
40-1039      \$29.95

This Pack Contains: (4) Messenger Expander Plates, (4) Messenger Extension Plates, (16) Screws, (16) Star Lock-Washers, (16) Nuts

# Tinplate Std. Gauge Track



Std. Gauge Track w/  
Roadbed - 1/2 42"  
Diam. Curve  
11-99043 \$5.49



Std. Gauge Track w/Roadbed - 72" Diam. Curve  
11-99072 \$6.99



Std. Gauge Track w/Roadbed - Lighted Lockon  
11-99004 \$5.99

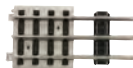

Std. Gauge Track w/  
Roadbed- Switch  
Adapter Track Section  
11-99011 \$8.99



Std. Gauge Track w/  
Roadbed - 3.5" Straight  
11-99018 \$4.99



Std. Gauge Track w/  
Roadbed - 14" Straight  
11-99001 \$6.49



Std. Gauge Track w/  
Roadbed - Adapter  
Track Section  
11-99010 \$8.99



Std. Gauge Track w/Roadbed - 7" Straight  
11-99002 \$5.49



Std. Gauge Track w/Roadbed - 1/2 72" Diam. Curve  
11-99073 \$5.99



Std. Gauge Track w/Roadbed - 28" Straight  
11-99003 \$12.99



Std. Gauge Track w/  
Roadbed - 42" Diam.  
Curve  
11-99042 \$6.49



Std. Gauge Track -  
84" Dia. Curved  
11-99095 \$6.99



Std. Gauge Track -  
42" Dia. Reg. Curved  
11-99093 \$5.49



Std. Gauge Track -  
Straight w/Extra Ties  
11-99092 \$5.99



Std. Gauge Track - 72"  
Dia. Wide Radius Curve  
11-99094 \$5.99



Std. Gauge Track -  
1/2 Reg. Straight  
11-99096 \$3.99



Std. Gauge Track - 36" Extra  
Ties Straight  
11-99099 \$10.99



Std. Gauge Track - 36" Straight  
11-99098 \$9.99



Std. Gauge Track -  
42" Diam. 1/2 Curved  
11-99097 \$3.99



Std. Gauge Track -  
14" Straight  
11-99091 \$5.49



O/Std. Gauge Tubular  
Track Activation Device (TAD)  
11-99090 \$14.95



Yellow - Std. Gauge  
#25 Illuminated  
Track Bumper Set  
11-99029 \$59.95

Green Base - Std. Gauge Switch -  
Right Hand 42" Diam.  
11-99044 \$109.95

Green Base - Std. Gauge Switch - Left  
Hand 42" Diam.  
11-99045 \$109.95

Green Base - Std. Gauge Switch (Wide  
Radius) - Right Hand 72" Diam.  
11-99074 \$119.95

Green Base - Std. Gauge Switch (Wide  
Radius) - Left Hand 72" Diam.  
11-99075 \$119.95



Std. Gauge #20 90 Degree Crossover  
11-99006 \$49.95

Black Base - Std. Gauge Switch -  
Right Hand 42" Diam.  
11-99046 \$109.95

Black Base - Std. Gauge Switch - Left  
Hand 42" Diam.  
11-99047 \$109.95

Black Base - Std. Gauge Switch (Wide  
Radius) - Right Hand 72  
11-99076 \$119.95

Black Base - Std. Gauge Switch (Wide  
Radius) - Left Hand 72  
11-99077 \$119.95



Std. Gauge #25  
Illuminated Track  
Bumpers  
11-99024 \$59.95



Orange - Std. Gauge  
#25 Illuminated Track  
Bumpers  
11-99030 \$59.95

# O Gauge ScaleTrax™

**It's not about the track.** Railroading is about huge machinery that makes the ground shake when it goes by. In model railroading, the track is a stage setting that should make your trains look more real and more massive — and no three-rail track does that better than ScaleTrax, the lowest-profile, best-running 3-rail O gauge track system.



## ScaleTrax Features

- Solid, rust-proof nickel silver rails
- Durable ties for years of use
- Easy, snap-together assembly
- Built-in electrical connections eliminate need for rail joiners or track pins
- Built-in Lockon receptacle in every track
- Non-derailing switches
- Snap-in, reversible switch motors
- Compatible with virtually all three-rail locomotives and cars

**Learn more:** Download our 16-page ScaleTrax brochure at [www.mthtrains.com](http://www.mthtrains.com)

IT TAKES **EIGHT O-31 CURVES** TO MAKE A CIRCLE.  
 IT TAKES **SIXTEEN O-54 CURVES** TO MAKE A CIRCLE.  
 IT TAKES **SIXTEEN O-72 CURVES** TO MAKE A CIRCLE.  
 IT TAKES **SIXTEEN O-80 CURVES** TO MAKE A CIRCLE.



ScaleTrax - 5.0" Track Section  
45-1013 \$3.99

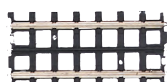

ScaleTrax - 4.25" Track Section  
45-1012 \$3.99



ScaleTrax - 1.75" Track Section  
45-1011 \$2.49

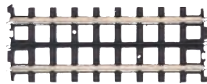

ScaleTrax - 5.5" Track Section  
45-1014 \$3.99



ScaleTrax - 10" Straight Track Section  
45-1001 \$4.99



ScaleTrax - 30" Track Section  
45-1019 \$13.99

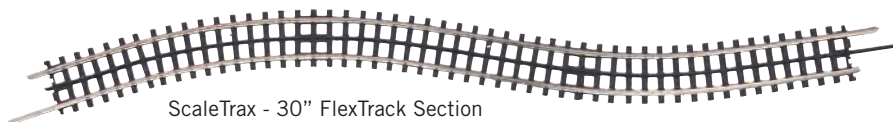

ScaleTrax - 30" FlexTrack Section  
45-1049 \$13.99



ScaleTrax - 22.5° Crossing  
45-1015 \$24.95

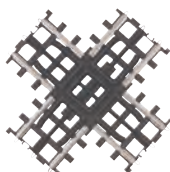

ScaleTrax - 90° Crossing  
45-1005 \$19.95

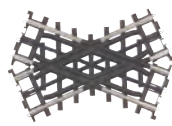

ScaleTrax - 45° Crossing  
45-1006 \$19.95

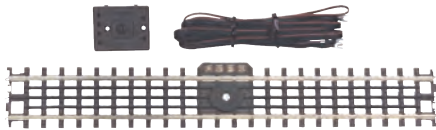

ScaleTrax - 15" Operating Track Section  
45-1035 \$24.95



ScaleTrax - O-31 Curved Track Section  
45-1002 \$4.99

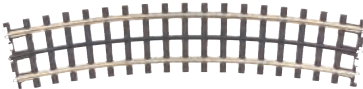

ScaleTrax - O-54 Curved Track Section  
45-1007 \$5.29

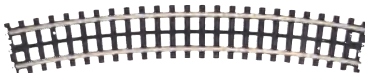

ScaleTrax - O-72 Curved Track Section  
45-1010 \$5.99

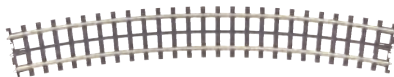

ScaleTrax - O-80 Curved Track Section  
45-1034 \$6.99

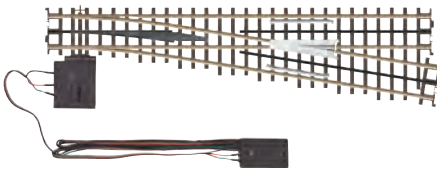

ScaleTrax - No. 6 Switch (LH)  
45-1052 \$89.95  
ScaleTrax - No. 6 Switch (RH)  
45-1053 \$89.95

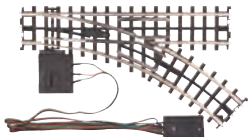

ScaleTrax - O-31 Switch (RH)  
45-1004 \$69.95  
ScaleTrax - O-31 Switch (LH)  
45-1003 \$69.95

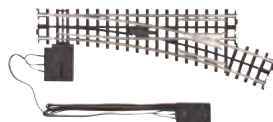

ScaleTrax - O-72 Switch (RH)  
45-1020 \$79.95  
ScaleTrax - O-72 Switch (LH)  
45-1021 \$79.95

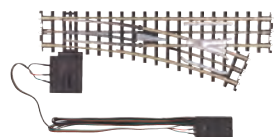

ScaleTrax - O-54 Switch (RH)  
45-1009 \$79.95  
ScaleTrax - O-54 Switch (LH)  
45-1008 \$79.95



ScaleTrax - Bumper  
45-1025 \$15.95

ScaleTrax - ITAD  
45-1028 \$34.95  
Enables passing train to activate signals and other accessories.



## ScaleTrax™ 2-Rail O-Scale Track



ScaleTrax - 2-Rail 17" Straight Track Section  
45-2017 \$7.99



ScaleTrax - 2-Rail 36" Radius Curved Track Section  
45-2036 \$8.99



ScaleTrax - 2-Rail 22" Radius Curved Track Section  
45-2022 \$7.99



ScaleTrax - Lockon  
45-1033 \$4.25  
Track Not Included



ScaleTrax - No. 4 Switch (LH)  
45-1050 \$89.95  
ScaleTrax - No. 4 Switch (RH)  
45-1051 \$89.95

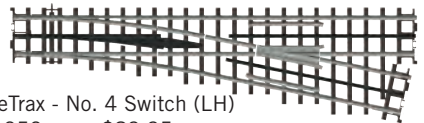

## ScaleTrax™ Layout Packages

Don't have the time or inclination to design your own layout? Check out ScaleTrax layout packages, featuring track plans designed in a variety of sizes and shapes, many with the ability to easily expand into a bigger and bigger empire. Each package includes all the track and switches needed to build a complete layout. For details and track plans, click the ScaleTrax logo at the bottom of the M.T.H. home page, [www.mthtrains.com](http://www.mthtrains.com). Order the Scaletrax components from any M.T.H. Authorized Retailer and M.T.H. will drop ship your order directly from Maryland. If you prefer to design your own plan use RR Track layout design software and take your design to any M.T.H. Authorized Retailer and we will drop ship the order for them.

### Roosevelt Junction

Roosevelt Junction starts small at just 4 ft. by 8 ft., but can grow in four phases to reach an awesome 8 ft. by 16 ft. railroading empire. Each 4 ft. by 8 ft. phase adds new operating possibilities. As you grown in the O Gauge railroading hobby, your layout can grow with you.

#### Roosevelt Junction - Phase 1

Roosevelt Junction begins as a small railroad with lots of fun. Sidings on both sides of the mainline allow for interesting switching operations between an engine yard and freights sidings. The mainline allows for continuous running when you want to sit back and watch the trains. The passing siding is long enough to accommodate most starter set trains, allowing two trains to pass each other.

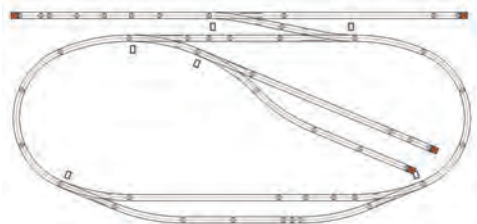

#### ScaleTrax Pieces

Item #	Description	MSRP	QTY	Extension
45-1001	10 inch straight	\$4.99	6	\$29.94
45-1002	0-31 curve	\$4.99	6	\$29.94
45-1010	0-72 curve	\$5.99	5	\$29.95
45-1011	1.75 inch straight	\$2.49	3	\$7.47
45-1012	4.25 inch straight	\$3.99	6	\$23.94
45-1013	5 inch straight	\$3.99	1	\$3.99
45-1014	5.5 inch straight	\$3.99	6	\$23.94
45-1019	30 inch straight	\$13.99	3	\$41.97
45-1020	0-72 RH switch	\$79.95	3	\$239.85
45-1021	0-72 LH switch	\$79.95	1	\$79.95
45-1025	bumper	\$15.95	4	\$63.80
45-1033	lock-on	\$4.25	6	\$25.50
45-1051	#4 RH switch	\$89.95	2	\$179.90
<b>45-1101</b>	<b>PACKAGE TOTAL: \$780.14</b>			



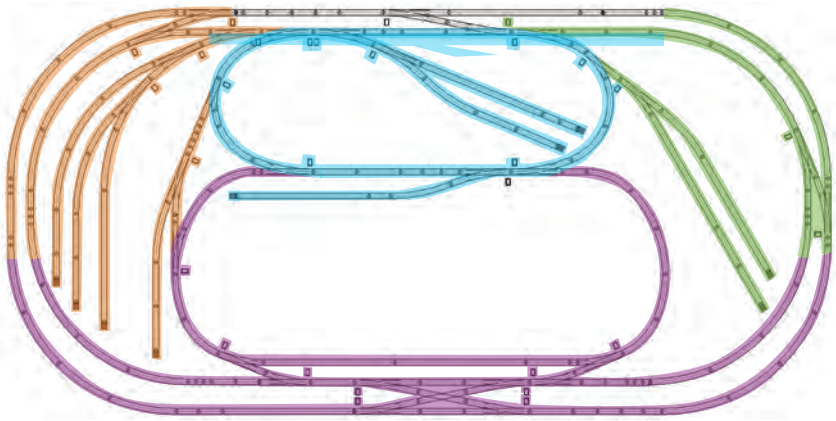

### Roosevelt Junction - Phase 2

The second phase of Roosevelt junction adds numerous operating possibilities. The mainline doubles in length, yard capacity nearly triples, and a reversing wye allows entire trains to change direction.

Item #	Description	MSRP	QTY	Extension
45-1001	10 inch straight	\$4.99	3	\$14.97
45-1002	0-31 curve	\$4.99	3	\$14.97
45-1003	0-31 LH switch	\$69.95	1	\$69.95
45-1007	0-54 curve	\$5.29	3	\$15.87
45-1009	0-54 RH switch	\$79.95	1	\$79.95
45-1010	0-72 curve	\$5.99	11	\$65.89
45-1011	1.75 inch straight	\$2.49	11	\$27.39
45-1012	4.25 inch straight	\$3.99	2	\$7.98
45-1013	5 inch straight	\$3.99	3	\$11.97
45-1019	30 inch straight	\$13.99	2	\$27.98
45-1020	0-72 RH switch	\$79.95	6	\$479.70
45-1021	0-72 LH switch	\$79.95	2	\$159.90
45-1025	bumper	\$15.95	4	\$63.80
45-1033	lock-on	\$4.25	7	\$29.75
45-1034	0-80 curve	\$6.99	1	\$6.99
<b>45-1102</b>	<b>PACKAGE TOTAL:</b>			<b>\$1077.06</b>

### Roosevelt Junction - Phase 3

The third phase of Roosevelt junction adds still more operating possibilities. The mainline again doubles in length and a long two-track spur is added making a perfect location for engine sheds or dead-end sidings.

Item #	Description	MSRP	QTY	Extension
45-1001	10 inch straight	\$4.99	6	\$29.94
45-1002	0-31 curve	\$4.99	2	\$9.98
45-1004	0-31 RH switch	\$69.95	1	\$69.95
45-1007	0-54 curve	\$5.29	2	\$10.58
45-1009	0-54 RH switch	\$79.95	1	\$79.95
45-1010	0-72 curve	\$5.99	5	\$29.95
45-1011	1.75 inch straight	\$2.49	5	\$12.45
45-1012	4.25 inch straight	\$3.99	1	\$3.99
45-1014	5.5 inch straight	\$3.99	1	\$3.99
45-1019	30 inch straight	\$13.99	2	\$27.98
45-1020	0-72 RH switch	\$79.95	2	\$159.90
45-1021	0-72 LH switch	\$79.95	1	\$79.95
45-1025	bumper	\$15.95	1	\$15.95
45-1033	lock-on	\$4.25	3	\$12.75
45-1034	0-80 curve	\$6.99	3	\$20.97
<b>45-1103</b>	<b>PACKAGE TOTAL:</b>			<b>\$568.28</b>

### Roosevelt Junction - Phase 4

The fourth and final addition to Roosevelt Junction transforms the layout into a hi-rail empire. The layout now sports a double track mainline with minimum O-72 curves as well as an interior O-31 loop allowing independent operations of three trains. Carefully located crossovers permit east access from either O-72 mainline into the yards. Three yard spurs connect to the mains with O-72 or larger curves so that even the largest articulated locomotives will feel right at home in Roosevelt Junction.

Item #	Description	MSRP	QTY	Extension
45-1001	10 inch straight	\$4.99	5	\$24.95
45-1007	0-54 curve	\$5.29	1	\$5.29
45-1008	0-54 LH switch	\$79.95	2	\$159.90
45-1009	0-54 RH switch	\$79.95	2	\$159.90
45-1010	0-72 curve	\$5.99	10	\$59.90
45-1011	1.75 inch straight	\$2.49	8	\$19.92
45-1013	5 inch straight	\$3.99	3	\$11.97
45-1014	5.5 inch straight	\$3.99	5	\$19.95
45-1015	22.5 deg crossing	\$24.95	1	\$24.95
45-1019	30 inch straight	\$13.99	2	\$27.98
45-1033	lock-on	\$4.25	5	\$21.25
45-1034	0-80 curve	\$6.99	4	\$27.96
45-1050	#4 LH switch	\$89.95	2	\$179.90
45-1051	#4 RH switch	\$89.95	2	\$179.90
<b>45-1104</b>	<b>PACKAGE TOTAL:</b>			<b>\$923.72</b>

# M.T.H. Trade Show Layout - 4 x 8 Freight Central

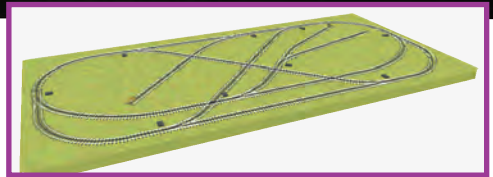
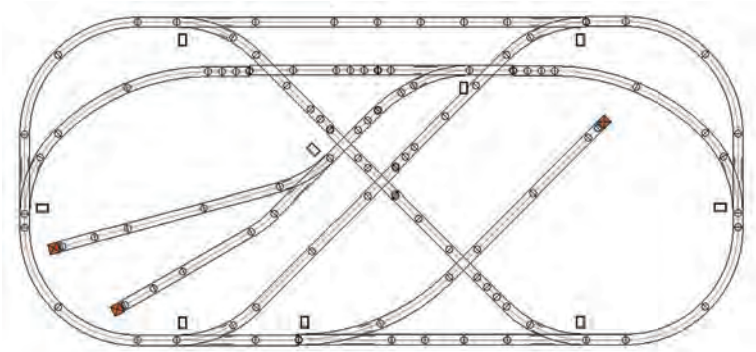

**SCALETRAX™**  
BY M.T.H. ELECTRIC TRAINS

ScaleTrax™ Pieces 45-1108

Item #	Description	MSRP	QTY	Extension
45-1001	10 inch straight	\$4.99	8	\$39.92
45-1002	0-31 curve	\$4.99	8	\$39.92
45-1003	0-31 LH switch	\$69.95	4	\$279.80
45-1004	0-31 RH switch	\$69.95	4	\$279.80
45-1005	90 deg crossing	\$19.95	3	\$59.85
45-1006	45 deg crossing	\$19.95	2	\$39.90
45-1007	0-54 curve	\$5.29	5	\$26.45
45-1008	0-54 LH switch	\$79.95	1	\$79.95
45-1011	1.75 inch straight	\$2.49	24	\$59.76
45-1012	4.25 inch straight	\$3.99	7	\$27.93
45-1013	5 inch straight	\$3.99	5	\$19.95
45-1014	5.5 inch straight	\$3.99	10	\$39.90
45-1025	bumper	\$15.95	3	\$47.85
45-1033	lock-on	\$4.25	4	\$17.00
<b>PACKAGE TOTAL:</b>				<b>\$1057.98</b>

# 8x9 Spare Room and Pacific RR

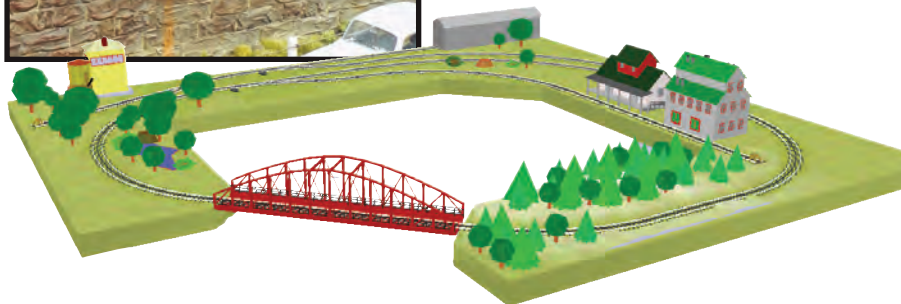
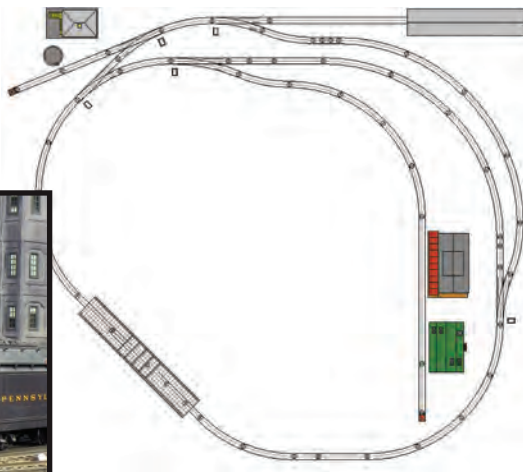

**SCALETRAX**<sup>™</sup>  
BY M.T.H. ELECTRIC TRAINS

## ScaleTrax™ Pieces 45-1105

Item #	Description	MSRP	QTY	Extension
45-1001	10 inch straight	\$4.99	9	\$44.91
45-1007	0-54 curve	\$5.29	19	\$100.51
45-1008	0-54 LH switch	\$79.95	1	\$79.95
45-1009	0-54 RH switch	\$79.95	3	\$239.85
45-1010	0-72 curve	\$5.99	7	\$41.93
45-1011	1.75 inch straight	\$2.49	5	\$12.45
45-1012	4.25 inch straight	\$3.99	3	\$11.97
45-1013	5 inch straight	\$3.99	2	\$7.98
45-1014	5.5 inch straight	\$3.99	2	\$7.98
45-1019	30 inch straight	\$13.99	2	\$27.98
45-1020	0-72 RH switch	\$79.95	1	\$79.95
45-1025	bumper	\$15.95	2	\$31.90
45-1033	lock-on	\$4.25	8	\$34.00
45-1034	0-80 curve	\$6.99	1	\$6.99
<b>PACKAGE TOTAL:</b>				<b>\$728.53</b>

# 6x10 Main Street

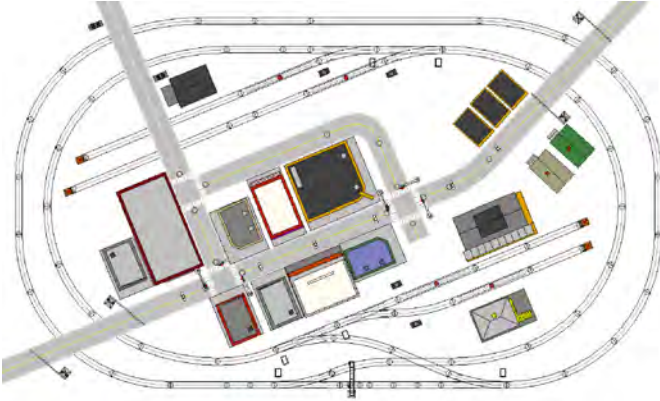

**SCALETRAX**<sup>™</sup>  
BY M.T.H. ELECTRIC TRAINS

## ScaleTrax™ Pieces 45-1107

Item #	Description	MSRP	QTY	Extension
45-1001	10 inch straight	\$4.99	10	\$49.90
45-1007	0-54 curve	\$5.29	30	\$158.70
45-1008	0-54 LH switch	\$79.95	3	\$239.85
45-1009	0-54 RH switch	\$79.95	3	\$239.85
45-1010	0-72 curve	\$5.99	2	\$11.98
45-1011	1.75 inch straight	\$2.49	3	\$7.47
45-1012	4.25 inch straight	\$3.99	5	\$19.95
45-1013	5 inch straight	\$3.99	2	\$7.98
45-1015	22.5 deg crossing	\$24.95	1	\$24.95
45-1019	30 inch straight	\$13.99	3	\$41.97
45-1025	bumper	\$15.95	4	\$63.80
45-1034	0-80 curve	\$6.99	4	\$27.96
45-1035	15" uncoupling section	\$24.95	4	\$99.80
<b>PACKAGE TOTAL:</b>				<b>\$994.16</b>

# 12x24 Timber Mountain



Model Photo Courtesy of John Sethian



**SCALETRAX™**  
BY M.I.H. ELECTRIC TRAINS

## ScaleTrax™ Pieces 45-1106

Item #	Description	MSRP	QTY	Extension
45-1001	10 inch straight	\$4.99	14	\$69.86
45-1006	45 deg crossing	\$19.95	2	\$39.90
45-1007	0-54 curve	\$5.29	10	\$52.90
45-1010	0-72 curve	\$5.99	41	\$245.59
45-1011	1.75 inch straight	\$2.49	4	\$9.96
45-1012	4.25 inch straight	\$3.99	5	\$19.95
45-1013	5 inch straight	\$3.99	1	\$3.99
45-1014	5.5 inch straight	\$3.99	2	\$7.98
45-1019	30 inch straight	\$13.99	30	\$419.70
45-1020	0-72 RH switch	\$79.95	1	\$79.95
45-1021	0-72 LH switch	\$79.95	5	\$399.75
45-1025	bumper	\$15.95	11	\$175.45
45-1033	lock-on	\$4.25	30	\$127.50
45-1034	0-80 curve	\$6.99	22	\$153.78
45-1049	30 inch flex	\$13.99	23	\$321.77
45-1050	#4 LH switch	\$89.95	3	\$269.85
45-1051	#4 RH switch	\$89.95	5	\$449.75
45-1052	#6 LH switch	\$89.95	4	\$359.80
45-1053	#6 RH switch	\$89.95	3	\$269.85
<b>PACKAGE TOTAL:</b>				<b>\$3477.28</b>

# POWER UP

with the best transformers in model railroading!



Z-1000™ Transformer  
40-1000 \$129.95

100-Watt Accessory Power Supply  
40-1000A \$89.95  
*With 14 Volt Accessory Port*

100  
Watts

Whether you operate with conventional AC power or the M.T.H. Digital Command System (DCS), our UL-approved transformers offer the best way to power your layout. Choose the 100-watt Z-1000™ for a small- to medium-sized layout, or step up to the 400-watt, feature-laden Z-4000®, the most powerful UL-approved transformer in the hobby. All M.T.H. AC transformers offer:

- Incredibly smooth, wide range throttle for precise speed control
- Bell and whistle/horn buttons that work with all makes of AC-powered locomotives
- Fast-acting circuit breakers to protect your equipment
- Continuous useable wave power output, compatible with all AC-powered engines



RailKing Controller Set  
40-750C \$59.95



*Includes Z Transformer Controller, RealTrax lock-on (40-1003), RealTrax wire harness (40-1015)*



TIU/Barrel Jack Adapter Cable  
50-1017 \$10.95



RealTrax Wire Harness  
40-1015 \$4.99

## DC Transformers



Z-DC1 DC Transformer  
40-200 \$29.95

20  
Watts

Z-DC300 30 Watt DC Transformer  
40-300 \$89.95



30  
Watts

- U.L. Approved
- Smooth Operating Throttle Knob
- Built-In Circuit Breaker Protection

# 400 Watts!

## The Most Powerful UL Listed AC Transformer!

Learn More About It  
The instruction manual for every  
M.T.H. transformer is available at  
[www.mthtrains.com](http://www.mthtrains.com)  
Just look up the transformer in our  
Product Search feature.



Z-4000® Transformer  
40-4000 \$479.95  
*Two throttles, each with its own complete set of controls, plus 10-volt and 14-volt accessory outputs*

Accepts bare wires, spade lugs, or banana plugs (recommended) for easy connections

### Rear Panel Outputs

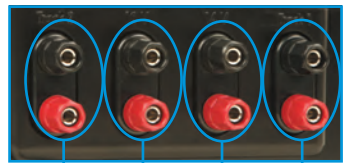

**0-22 Volts Track Power (10 AMP)**

**10-Volt Accessory Power (3 AMP)**

**14-Volt Accessory Power (3 AMP)**

**0-22 Volts Track Power (10 AMP)**

### WHY THE UL OR SP LISTING?

To protect our customers and their trains, M.T.H. Electric Trains is committed to manufacturing safe, UL or CSA approved transformers and power supplies. By subjecting our transformers to the strenuous tests and requirements of Underwriters Laboratories and/or CSA, M.T.H. helps ensure that our products meet the same requirements as other consumer electronics sold today. When choosing a new transformer, model railroaders should only look for those that have received a UL or CSA listing.



# SIMPLY THE BEST

DCS is **SIMPLE** to use.

It's **ACCESSABLE** from any iOS or Android smart phone or tablet.

It can be **UPGRADED FOR FREE** over the Internet.

It can **DO MORE** for less money than other command control systems.

It's why you'll have **MORE FUN** operating your trains than ever before.

It can run over 6,000\* Proto-Sound® 2.0 & 3.0 engines and every Lionel® TMCC®, EOB, or Legacy™ engine ever made — and run 99 of them at the same time, on the same track, independently, in command mode.

It can also **RUN ALL CONVENTIONAL AC LOCOMOTIVES** without the purchase of any additional hardware.

With the addition of an Accessory Interface Unit (AIU), it can **OPERATE ANY 0 SCALE ACCESSORY OR SWITCH**. It can **CREATE SCENES AND ROUTES** that are triggered with one push of a button.

\* Number of different Proto-Sound 2.0 and 3.0 engines cataloged through the 2017 Volume 2 Catalog. While all Lionel TMCC features can be accessed by the DCS handheld remote, at present some Legacy features cannot be accessed by a DCS remote.



Learn More About It  
Shop Online at  
[www.mthtrains.com](http://www.mthtrains.com)

## DCS COMPONENTS

- DCS Remote Control System  
50-1001 \$349.95
- DCS Remote Control -  
Handheld Unit  
50-1002 \$169.95



- DCS Track Interface  
Unit (TIU)  
50-1003 \$199.95



- DCS Accessory Interface  
Unit (AIU)  
50-1004 \$119.95

- DCS WiFi Module  
50-1034 \$179.95



- Proto-Sound Battery  
50-1008 \$11.95
- AA NiCad Proto-Sound Battery  
50-1024 \$11.95
- Proto-Sound 2.0 Battery Charger  
50-1019 \$19.95
- TIU/TMCC-Legacy 6'  
Connector Cable  
50-1032 \$24.95
- 6' Mini-to-Mini Cable  
50-1009 \$9.95
- 12-Port Terminal Block  
50-1014 \$27.95
- 24-Port Terminal Block  
50-1020 \$37.95
- Z-DC24 24-Watt Power Supply  
50-240 \$17.95
- DCS 0 Gauge Companion  
Digital Book - 2nd Edition  
60-1279 \$12.95



# WAY TO RUN A RAILROAD™

## Command Control Explained

In conventional operation, an AC or DC transformer varies track voltage to adjust engine speed and direction. Command systems such as DCS, however, put a constant voltage on the track (around 18 volts for DCS) and vary speed by telling each engine how much of that voltage to use. Command control allows different engines to do different things — like run at different speeds, go in different directions, or make different sounds — even when they are on the same track.

In the DCS system, commands such as speed, direction, and sound control are sent as radio signals from the handheld throttle to a TIU (track interface unit). The TIU translates those radio signals into digital information that is sent through the rails and picked up by a receiver in the appropriate engine — telling it to go, for example, 37 miles per hour, blow the whistle,

smoke more heavily, or any other command. DCS locomotives can also send information back to the handheld to let the operator know what they're doing.



### Learn More About It

Request a Complimentary DVD on DCS and M.T.H. technology. Log on to the DCS web site, [www.protosound2.com](http://www.protosound2.com)

### Try It at your local DCS Demo Center

Take your favorite Proto-Sound 2.0 or 3.0 engine to any DCS Demo Center and experience the additional features your engine has with DCS control. To find your nearest demo center or request your complimentary DVD, visit [www.mthtrains.com](http://www.mthtrains.com).

## M.T.H. Railroading App

Technology continues to expand in all aspects of our lives; we believe it must continue to do so in our products and our control systems if we want our hobby to remain relevant in the world of smart phones, tablets and wearable technology.

Why put a remote control in the hands of an operator when he or she probably has an even more powerful device in their pocket? Why shouldn't a modeler control their layout with their phone, when they can already use that phone to run their television, adjust their thermostat, and activate their home alarm system? More importantly, how many new members can we attract into our hobby when we bundle that hobby with technology they use every day?

### Enter our first model railroading app

Our new smart phone and tablet app allows operators to run their trains from Apple iOS or Android phones or tablets. That means your Apple iPhone or Samsung Galaxy can do one more thing we only dreamed about fifteen years ago when we introduced DCS. Your favorite Android tablet or Apple iPad will bring the DCS Digital Command System to life in a way you



never thought possible when you first picked up a DCS remote control. Any of these smart devices can run our new app. That means anybody who visits your layout can run trains — the days of fighting over the remote control are over!

Whether you're running Android or iOS, our DCS app allows you to control your entire layout in command or conventional modes without using a DCS handheld remote. You'll still need a TIU (Track Interface Unit) along with a new, separately sold DCS WiFi module.

Simply plug the module into the TIU, search for its WiFi signal on your phone or tablet, and you'll be running your layout in command mode in no time. Everything the DCS handheld remote can do, the app can do — but your experience will be better and in full color!

Our new app isn't limited to just DCS control either. With it, you can access special pages on the M.T.H. website, see the latest catalogs and news articles, and shop for M.T.H. products.

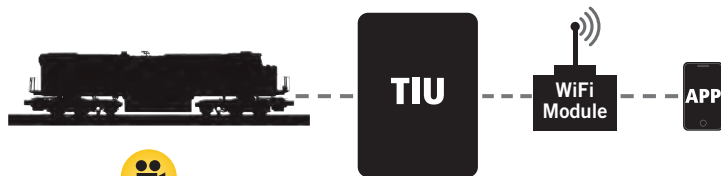

See a Demo at [www.mthtrains.com](http://www.mthtrains.com)

## What Can Your Remote Do?

# DCS COMMANDER

HO DIGITAL COMMAND SYSTEM CONTROLLER

## More Features Than Analog DC or DCC Command Control Run Up To 10 Engines At Once!

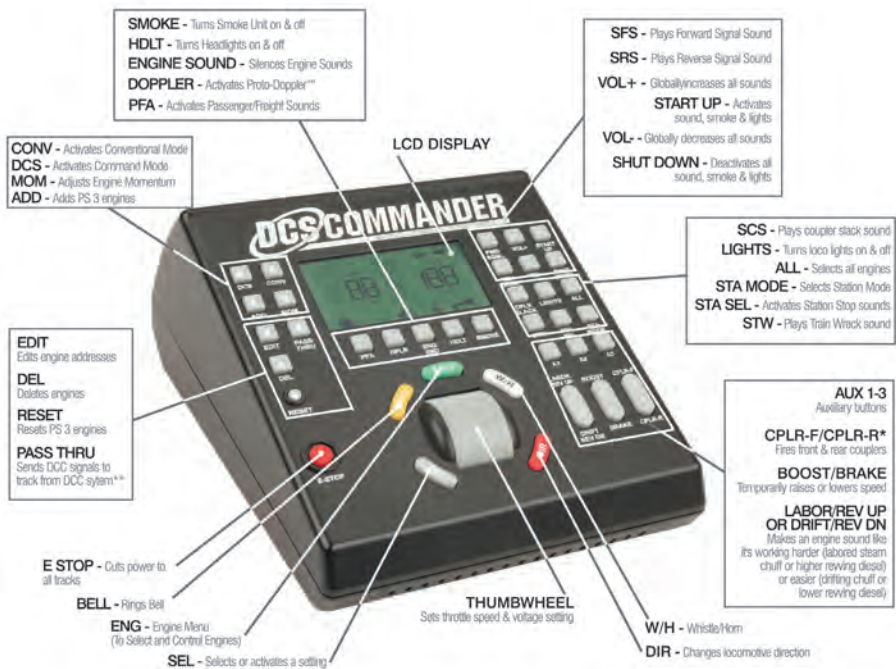

\* Operating couplers are not available on HO locomotives at this time.

\*\* Customer supplied DCC system Required

The next generation of the DCS Digital Command System is here. The all-new DCS Commander brings a less expensive, but powerful command control device to your O Gauge and HO DC powered layouts. Connect a DCS Commander between the wires of your existing DCC system or DC power supply to the track and you can switch back and forth between DCS and Analog DC operating modes with just a push of a button.

Because M.T.H. Proto-Sound 2.0 or 3.0 locomotives can operate on both AC or DC current, the DCS Commander may be the affordable DCS command control option you've been looking for. Available alone or bundled with a 100 watt power supply, The DCS commander outputs 18 volts of DC power and includes

a built-in 5amp resettable breaker making it a perfect solution for small M.T.H. O Gauge layouts exclusively running Proto-Sound 2.0 or 3.0 locomotives.

For HO operators, the DCS Commander Controller Set is a perfect power solution for almost any size HO layout. HO operators whose layouts are already outfitted with a DC power supply can choose the individual DCS Commander and plug their existing power supply right into the Commander's power inputs.

The DCS Commander provides the user with intuitive control of multiple Proto-Sound 2.0\*\* or later equipped locomotives. For each locomotive, more than 32 functions are available at the touch of a single clearly-labeled button.



## Perfect for Any Proto-Sound 2.0 or 3.0 Equipped Train Set!

DCS Commander System  
w/100 Watt Power Supply  
50-1029 \$259.95

DCS Commander Controller  
50-1028 \$179.95

### Features Include:

- Speed adjustment in one-scale mile-per-hour steps
- Independent feature control: tune your engines' sound, lights, smoke and acceleration/deceleration settings
- Smoke On/Off
- Doppler Sounds: simulate the classic sound effect of a train approaching and then whizzing past
- Accent Sounds: activate any one of 7 individual sounds, including signal forward and reverse sounds, coupler slack, engine start-up and shut-down, engine labor and engine drift
- Activate Passenger Station and Freight Yard Sounds
- Individual locomotive control: select up to 10 Proto-Sound 2.0 or later engines
- Selectable control mode configurations: choose between analog DC, DCC and DCS operating modes
- Track Signal Test: test your layout's signal strength using the built-in signal strength analyzer.
- Proto-Whistle Quillable Sound Activation: access the built-in Proto-Whistle quillable sounds\*\*\* found inside your Proto-Sound 2.0 or later locomotives and using the thumbwheel to "play" your locomotive's whistle just like a real engineer!
- Access Whistle Signal Sounds: activate grade crossing whistle signals\*\*\*\* on your Proto-Sound 2.0 or later equipped locomotive

\*\* Requires Proto-Sound 2.0 locomotive onboard 3-volt system or Proto-Sound 3.0 locomotive onboard system. Proto-Sound 2.0 3-volt systems are identified by their square battery charging jack on the locomotive chassis. See the locomotive's operator's manual for the exact location of the charging jack.

\*\*\* Proto-Whistle quillable sounds not found in all Proto-Sound 2.0 or later equipped locomotives. Refer to your locomotives operator's manual to determine if your locomotive is equipped with Proto-Whistle quillable sounds.

\*\*\*\*Proto-Whistle grade crossing signals not found in all Proto-Sound 2.0 or later equipped locomotives.

## DCS Remote Commander Set

The DCS Remote Commander is an inexpensive wireless solution capable of accessing the most popular command control functions programmed into Proto-Sound 2.0 or 3.0 locomotives. The DCS Remote Commander handheld controller features clearly labeled, one-button control of 9 engine functions. There are no function keys or special codes to remember. Access the locomotive whistle or horn, bell, smoke, direction and speed with just a single button push. You can also access Passenger Station or Freight Yard Proto-Effects, engine startup and shutdown sounds and control the front or rear Proto-Couplers with this lightweight, easy-to-use remote.

Adding a DCS Remote Commander to your existing layout is simple: just plug your power supply into the DCS Remote Commander receiver and the output wires from the receiver to your track lockon. The DCS Remote Commander can accept any power input (AC or DC) up to 20 volts and 8 amps, making it a perfect choice for small and moderately sized layouts.

DCS Remote Commander Set  
50-1033 \$59.95

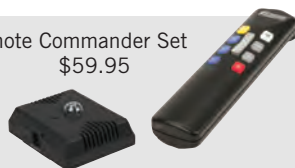

### Features Include:

- Speed adjustment in one-scale-mile-per-hour steps
- Volume Control
- Smoke on/off
- Front & Rear Proto-Coupler Control
- Engine Start-up & Shutdown Sounds
- Activate Passenger Station and Freight Yard Sounds
- Whistle/Horn Control & Bell On/Off
- Locomotive Direction Control
- Wireless Communication With DCS Remote Commander Receiver
- LED Power On Lamp (Receiver Only)
- AC or DC Power Input
- Remote Requires (2) AA Batteries (not included)
- Unit Measures: 6 inches

# M.T.H. Railroaders Club™

**JOIN  
THE CLUB**

There are **TEN** different types of memberships, based on the style of model railroading that most interests you.

**JOIN ONLINE! IT'S EASY - JUST GO TO [WWW.MTHTRAINS.COM](http://WWW.MTHTRAINS.COM)**

## RailKing Membership



30-76674 MTHRC Flat Car  
w(1) Ford Transit Van

**RailKing Membership is \$50.00**

## Tinplate O Gauge Membership



10-8088 MTHRC No. 2814R O Gauge  
Refrigerator Car

**Tinplate 2800 Series Membership is \$90.00**

## Lionel Corp. O Gauge Membership



11-70163 Lionel Corporation  
No. 2814R O Gauge Refrigerator Car

**Lionel Corp. 2800 Series Membership is \$90.00**

## One-Gauge Membership



70-73060 BNSF Unibody Tank Car  
**One-Gauge Membership is \$100.00**

## Basic Membership

60-1000 - The Basic Club Membership does not include a club car  
Basic Membership is \$25.00

90

## Premier Membership



20-93717 Pullman Standard 40' Box Car  
**Premier Membership is \$55.00**

## Tinplate Std. Gauge Membership



10-2248 MTHRC No. 214R Std. Gauge  
Refrigerator Car

**Tinplate 200 Series Membership is \$120.00**

## Lionel Corp. Std. Gauge Membership



11-30248 Lionel Corporation  
No. 214R Std. Gauge Refrigerator Car  
**Lionel Corp. 200 Series Membership is \$120.00**

## HO Membership



85-74137 Chesapeake & Ohio - 40' PS-1 Box Car  
**HO Membership is \$30.00**

## S Gauge Membership



35-74017 Chesapeake & Ohio Rebuilt Steel Box Car  
**S-Gauge Membership is \$55.00**

# AS A MEMBER OF THE M.T.H. RAILROADERS CLUB YOU'LL RECEIVE:



## Limited-Edition Club Car

Each year we produce beautifully decorated cars exclusively for our Club members. Members automatically receive the car that matches their Club membership (RailKing, Premier, Tinplate, S Gauge, HO, or One Gauge) and have the option to collect the other Club cars as well.



## The CrossingGate™ Club Magazine

You will receive our quarterly full color Club magazine, jam-packed with product news, layout visits, rail history, and step-by-step articles on how to enjoy M.T.H. products even more.



## 1st Class Mailing of M.T.H. Catalogs

Club Members get all of our catalogs earlier than all our other mailing list members, via First-Class mailings, so they can order from their local train store before the best items are sold out.



## RailWare™ Software DVD

Use your computer to design track layouts, search the database of all M.T.H. products, look at our past catalogs, listen to Proto-Sound 3.0 train effects, and much more. This DVD retails for \$79.95, but is yours FREE as a Club member.



## Unique Club Products and Discounts

You'll have the option to purchase uncataloged members-only engines and rolling stock, and take advantage of members-only discounts on select cataloged items.



## Club Card & Lapel Pin

Show the world your membership in this elite group of model railroaders with your high-quality embossed membership card and beautiful enameled lapel pin.



## Proto-Sound@ 3.0 Upgrade Kits

Club members can save an additional 15% on these kits for upgrading older locomotives.

## Club Web Site

Visit [www.mthtrains.com](http://www.mthtrains.com) & type in your member number to gain access to the Club web site. Here you can exchange messages with other Club members, and even build your own homepage.

## CARRY ON THE M.T.H. TRADITION WITH MEMORABILIA AND COLLECTIBLES

### MTH Promotional DVD

This interactive DVD is packed full of sights & sounds guaranteed to make you rethink how far the hobby of model railroading has come. You'll learn about some of the most innovative products ever produced and marvel at the sophistication of a product line unmatched by other model train manufacturers.

### Previous Year Club Cars

MTHRRRC members can still obtain earlier produced MTHRRRC cars by visiting the MTHRRRC pages on the website. Only MTHRRRC members can get these cars!



### A Toy Train Story

This comprehensive history of M.T.H. is a must for toy train hobbyists. 350 pages & 1900 color photos, hard cover. Add this book to your membership for only \$25.00 (50% off the \$49.95 cover price)!



# www.mthtrains.com

We don't think we're exaggerating when we say M.T.H. has the most useful train manufacturer's site on the Internet. Here's just a sample of the answers you can find online.



## WHAT'S THE LATEST INFO ON ...?

Use Product Search to find the latest info on new products before they're delivered — sound sets, cab numbers, feature and paint scheme updates, and other information that arrived after the catalog was published.

## DID YOU EVER MAKE .....?

Use Product Search to search through nearly all of the 15,000 items we've made in the past 37 years, for your favorite road name, engine, or type of rolling stock.

## DOES ANY DEALER STILL HAVE ...?

Locate hard-to-find items with our Product Locator, which searches the inventories of M.T.H. dealers across the country.

## HOW DOES IT WORK?

Misplaced an instruction manual or just want to know how a product works? Use Product Search to look up the item and view its instruction manual.



## WHEN IS IT COMING?

Our online Shipping schedule is updated frequently to let you know what's coming soon to your hobby shop.

## ARE YOU GOING TO MAKE .....?

View the last several M.T.H. Catalogs online. Or click on Video to see M.T.H. products in action.

## HOW CAN I FIX...?

The Service area of our site allows you to email a question to our factory technicians or find which of our 150+ local service centers is closest to you.

## WHAT REPAIR PART DO I NEED?

Use Product Search to find exploded diagrams and parts lists for M.T.H. locomotives and accessories, and then order the parts online or by phone.



## WHAT'S NEW?

New arrivals and other news are posted frequently on our home page.

## HOW CAN I LEARN MORE ABOUT DCS?

Follow the link to the protosound2.com Web site for DCS and Proto-Sound information — and a list of Authorized DCS Demo Centers where you can try DCS hands-on.

## HOW CAN I UPDATE MY DCS SYSTEM OR CHANGE A SOUND SET?

Only M.T.H. allows you to update your control system or change an engine's sound set right over the Internet. Follow the link to the protosound2.com Web site for DCS and Proto-Sound 3.0 downloads.

To get the news as it happens, sign up for our free weekly electronic newsletter, with information on new M.T.H. products, industry news, and sneak peeks at upcoming specials!

**Just go to [mthtrains.com](http://mthtrains.com) and click on Newsletter Signup.**

Not all products depicted in this catalog are production models. In some cases, the items pictured may be HO, O Scale or some other scale product.

All item's graphic features and content are subject to change after publication. All product features may be verified on their retail packages.

©2017, M.T.H. Electric Trains,  
7020 Columbia Gateway Drive  
Columbia Maryland 21046-1532  
[www.mthtrains.com](http://www.mthtrains.com) - (410) 381-2580

MTH Trademarks: M.T.H. Electric Trains®, M.T.H.®, MTH Railroaders Club™, Ives®, Loco-Sound™, Proto-Sound® 2.0, Proto-Sound 3.0®, Proto-Speed Control™, Proto-Doppler™, Proto-Dispatch™, Proto-Cast™, ProtoSmoke™, Proto-Coupler™, Proto-Effects™, Proto-Scale 3-2™, RailKing®, Rugged Rails®, RailKing One-Gauge™, RailTown™, Timpale Traditions™, ScaleTrax™, RealTrax®, Z-500™, Z-750™, Z-4000®, Z-1000™, Z-4000, DCS ... simply the best way to run a railroad™, A World of Your Own in Three Dimensions™, Build a World of Your Own in Three Dimensions™, Remote Commander™,

DCS™ and the MTH Numbering System and all others indicated throughout this catalog. RealTrax® layouts created with RR-Track™ which is a registered trademark of R&S Enterprises.

Greyhound is a registered trademark of the Greyhound Lines, Inc.

Products bearing Chicago and North Western, Denver & Rio Grande, Denver & Rio Grande Western, MKT/Katy, Missouri Pacific, Southern Pacific, Union Pacific and Western Pacific logos and/or lettering are made under trademark license from Union Pacific Railroad Company.

Lionel is a registered trademark of Lionel Trains LLC. FasTrack™, TMCC®, TrainMaster®, CAB-1® Remote Controller, and Lionel® are all registered trademarks owned by Lionel L.L.C. All Rights Reserved.

Kadee® is a registered trademark of Kadee Quality Products Co.

M.T.H.'s DCS Digital Command System has received U.S. Patent No. 6,457,681. M.T.H.'s Proto-Sound 2.0 system has received U.S. Patent No's 6,457,681 B1 (sound system), 6,457,681 B1 (Proto-Speed Control), 6,604,641 (Proto-Coupler), 6,280,278 (Proto-Smoke). M.T.H.'s RealTrax has received U.S. Patent No. 6,019,289.

M.T.H.'s ScaleTrax switches have received U.S. Patent No. 6,491,263.

M.T.H.'s Z-4000 Transformer has received U.S. Patent No's. 6,281,606 & 6,624,537.

M.T.H.'s Proto-Scale 3-2 has received U.S. Patent No. 6,662,917  
Some images used in this publication ©2016 [www.clipart.com](http://www.clipart.com)

M.T.H. Electric Trains is in no way affiliated with any of the railroads featured in this catalog.

# DCS™ WiFi

BY MTH ELECTRIC TRAINS  
DIGITAL COMMAND SYSTEM



Simply  
the Best Way  
to Run a  
RailRoad™



**View Our Full 2017 Lineup Online**



Sign up for our free weekly electronic newsletter, with new products and upcoming specials, at [www.mthtrains.com](http://www.mthtrains.com)

Go to [www.mthtrains.com](http://www.mthtrains.com) and click on "Catalogs"

**WWW.MTHTRAINS.COM**

© 2017 M.T.H. Electric Trains  
7020 Columbia Gateway Drive, Columbia, Maryland 21046

